

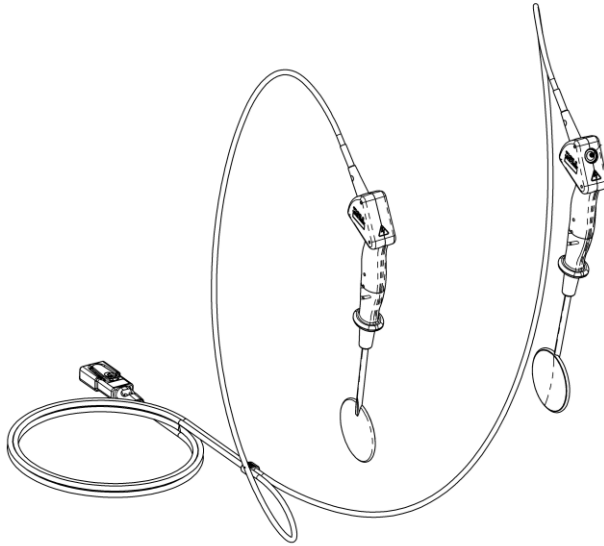

## Operator's Guide



---

Autoclavable Internal Handles with Integrated Paddles

**ZOLL**<sup>®</sup>

9650-0550 Rev. U

The issue date for the **Autoclavable Internal Handles with Integrated Paddles Operator's Guide (REF 9650-0550 Rev. U)** is **May, 2024**.

Copyright © 2024 ZOLL Medical Corporation. All rights reserved. ZOLL, R Series and X Series are trademarks or registered trademarks of ZOLL Medical Corporation in the United States and in other countries. All other trademarks and registered trademarks are the property of their respective owners.

Propaq is a registered trademark of Welch Allyn, Inc.



**ZOLL Medical Corporation**  
269 Mill Road  
Chelmsford, MA USA  
01824-4105



**ZOLL International Holding B.V.**  
Einsteinweg 8A  
6662 PW Elst  
Netherlands



**ZOLL Medical Switzerland AG**  
Baarerstrasse 8  
6300 Zug  
Switzerland

















**0123**

## Degree of Protection Against Electrical Shock

The ZOLL Autoclavable Internal Handles with Integrated Paddles are classified as Type CF, Defibrillator Protected equipment.

## Symbols Used on the Equipment

Any or all of the following symbols may be used in this manual or on this equipment:

-  Type B patient connection.
-  Type BF patient connection.
-  Type CF patient connection.
-  Defibrillator-proof type BF patient connection.
-  Defibrillator-proof type CF patient connection.
-  **ATTENTION** Refer to manual for more information
-  Fusible Link.
-  Protective (earth) ground terminal.
-  Equipotentiality
-  **DANGER** High voltage present
-  Alternating current.
-  **Conformité Européenne** Complies with the Medical Device Directive 93/42/EEC.
-  Indicates the item is a medical device.
-  Indicates a carrier that contains Unique Device Identifier information.



Indicates the entity importing the medical device into the locale.



Authorized representative in the European Community.



Indicates the authorized representative in Switzerland.

### Notification of Adverse Events

As a health care provider, you may have responsibilities under the Safe Medical Devices Act (SMDA) for reporting to ZOLL and possibly to the Food and Drug Administration (FDA), the occurrence of certain events. These events, described in 21 CFR Part 803, include device related death and serious injury or illness. In any event, as part of our Quality Assurance Program, ZOLL should be notified of any device failure or malfunction. This information is required to assure that ZOLL provides only the highest quality products.

If any serious incident has occurred in relation to the device, the incident should be reported to the manufacturer and the competent authority of the Member State in which the user and/or patient is established.

### Service

#### U.S.A. Customers

Should the ZOLL Internal Handle set require service, contact ZOLL Medical Corporation at 1-800-348-9011 or 1-781-229-0020.

You will be given a Return Service Request number under which to return the ZOLL Internal Handles. Send the unit in its original packaging or equivalent to:

For customers	Return the unit to
In the U.S.A.	ZOLL Medical Corporation 269 Mill Road Chelmsford, MA 01824-4105  Attention: Technical Service Department ( <i>SR number</i> )  Telephone: 1-800-348-9011
In Canada	ZOLL Medical Canada Inc. 1750 Sismet Road, Unit #1 Mississauga, ON L4W 1R6  Attention: Technical Service Department ( <i>SR number</i> )  Telephone: 1-866-442-1011
In other locations	The nearest authorized ZOLL Medical Corporation representative.  To locate an authorized service center, contact the International Sales Department at  ZOLL Medical Corporation 269 Mill Road Chelmsford, MA 01824-4105  Telephone: 1-978-421-9655

For additional information on the product, its preparation for use, cleaning, sanitizing, sterilizing or other questions on infection control procedures for this product, please contact ZOLL Technical Service at 1-800-348-9011 or 1-781-229-0020.

**International Customers**

Should the ZOLL Internal Handles require service, they should be returned, in their original container or equivalent, to the nearest authorized ZOLL Medical Corporation service center.

# Table of Contents

Degree of Protection Against Electrical Shock.....	i
Symbols Used on the Equipment .....	i
Service .....	i
ZOLL Autoclavable Internal Handles with Integrated Paddles.....	1
Indications for Use .....	1
Using the Internal Handles with R Series Defibrillators .....	1
Potential Adverse Effects .....	2
Types of Internal Handles with Integrated Paddles Sets .....	2
Cleaning and Disinfection .....	3
Selection of Appropriate Paddle Size .....	10
Verification of Operation Prior to Each Use .....	10
Defibrillation Procedure.....	12
Three Month Checkout Procedure.....	13
Six Month Checkout Procedure .....	14
Ordering Additional Parts.....	15

# ZOLL Autoclavable Internal Handles with Integrated Paddles

## Indications for Use

The ZOLL Autoclavable Internal Handles with Integrated Paddles are intended for use by a physician or trained medical personnel familiar with treating cardiac arrest in an emergency room or operating room setting. A clinician is required to manually place the electrode paddles in direct contact with a patient's heart during an open chest procedure when a victim of suspected cardiac arrest has an apparent lack of circulation as indicated by absence of pulse or signs or circulation.

The ZOLL® Autoclavable Internal Handles with Integrated Paddles are designed for use with ZOLL X Series®, Propaq® MD, and R Series® defibrillators to defibrillate the heart during open chest surgical procedures.

ZOLL defibrillators equipped with an advisory ECG analysis feature will only operate as manual defibrillators when the internal handles are attached.

The Operator's Guide for your ZOLL defibrillator must be used in conjunction with this guide.

### Notes:

- This manual describes the use of the ZOLL Autoclavable Internal Handles with Integrated Paddles only. For instructions related to the use of other ZOLL internal handles, see the applicable Operator's Guide.
- Cleaning and sterilization protocols for other ZOLL internal handle sets differ significantly and instructions in the applicable Operator's Guide must be followed.
- The ZOLL Autoclavable Internal Handles with Integrated Paddles are intended for use by or under the direction of a physician.

## Using the Internal Handles with R Series Defibrillators

The use of the Autoclavable Internal Handles with Integrated Paddles with R Series defibrillators is subject to the following restrictions when used in a 220/240 VAC 50 Hz or 60 Hz power environment:

### **WARNING**

**DO NOT OPERATE AUTOCLAVABLE INTERNAL HANDLES, REF 8011-0139-xx (with 10 ft. cable), in 220/240 VAC 50 HZ OR 60 HZ POWER ENVIRONMENTS. The use of these internal handles in a 220/240 VAC 50 HZ OR 60 HZ power environment may result in unacceptably high leakage currents and compromise patient safety.**

**To use Autoclavable Internal Handles with Integrated Paddles with a ZOLL R Series Defibrillator in a 220/240 VAC 60 Hz environment, you must use only the Autoclavable Internal Handles with Integrated Paddles, REF 8011-0141-xx (with 7 ft. cable), with the ZOLL One-Step Cable (REF 1009-0913-01) or ZOLL Multifunction (MFC) Cable (REF 1009-0913-03).**

## Potential Adverse Effects

Potential adverse effects (e.g. complications) associated with use of Internal Handles include:

- Failure to deliver a defibrillation shock
- Bystander shock from patient contact during defibrillation
- Interaction with ICDs (pacemakers)
- Infections, burns and mechanical damage

## Types of Internal Handles with Integrated Paddles Sets

The Internal Handles with Integrated Paddles Sets are available in two styles (shown below). Style A internal handles (**REF 8011-0139-xx** and **REF 8011-0141-xx**) include a button on the apex handle whose activation initiates discharge of the attached defibrillator. Style B internal handles (**REF 8011-0140-xx**) do not include a discharge button. Discharge of the defibrillator is affected by the depression of the front panel SHOCK button when using Style B internal handles.

Please note that both internal handle styles are available with several different integrated paddle/spoon sizes. See the "Ordering Additional Parts" table at the end of this manual to determine the appropriate value of **-xx**, shown in these part numbers.

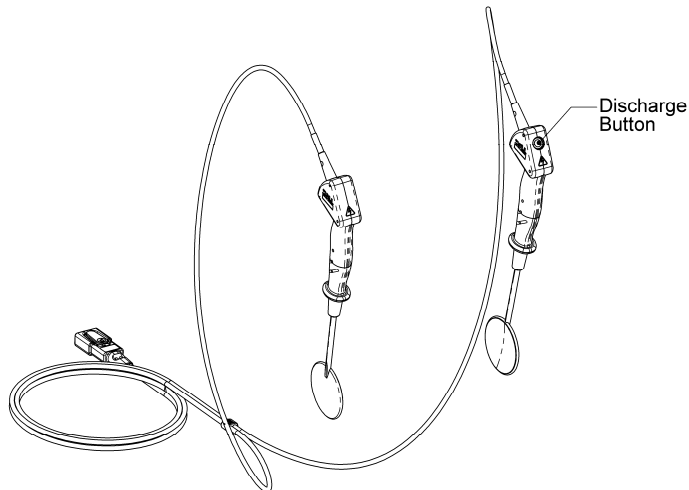

**Style A Internal Handles with Discharge Button**

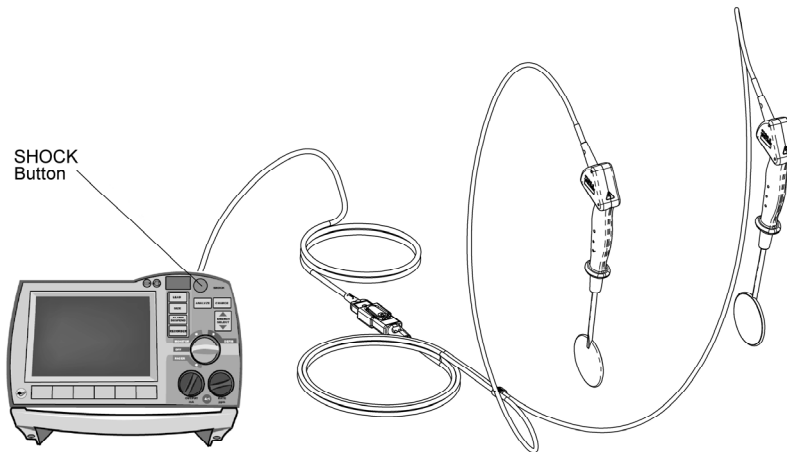

### **Style B Internal Handles without Discharge Button**

Connection of the internal handle set to the appropriate defibrillator automatically causes the unit to limit its energy output to a maximum of 50 Joules.

The internal handle set can be sterilized by autoclaving according to the guidelines provided in this document.

## **Cleaning and Disinfection**

### **NOTES:**

- The following process for cleaning and sterilization of the Autoclavable Internal Handles with Integrated Paddles has been validated to be effective in the disinfection of these products. Product users are responsible for qualifying any deviation from this recommended method of processing.
- All cleaning agents should be prepared and used according to the manufacturer's instructions and product labeling.

Follow local protocols for disposing contaminated devices.

Do not allow the internal handle sets to dry after use and before cleaning (more than 4 hours). Items contaminated with blood and/or other protein materials cannot be effectively cleaned if allowed to dry.

The Internal Handle Set (including the connector) and Integrated Paddles may be immersed, if necessary, during cleaning. The connector cap can be removed.

The handle set must be hand washed or machine washed. Do not subject them to ultrasonic washing machines.

To ensure the integrity of the internal handle set, perform a functional test prior to each use (see "Verification of Operation Prior to Use").

Do not disassemble the internal handle sets. Any attempt to disassemble the internal handle sets will void any applicable warranties.



The Internal Handle with Integrated Paddles can be sterilized by either Steam Sterilization in a Pre-Vacuum Autoclave according to the guidelines provided in this document or by the STERRAD® 100S/NX® Sterilization System.

## CAUTIONS

- The Autoclavable Internal Handles with Integrated Paddles are sold and shipped in a non-sterile condition. They should be cleaned and sterilized following the procedures outlined below prior to their first use and after each reuse.
- Do not drop, bump or knock the internal paddles. Damage to the insulating coating of the paddle may occur.
- Inspect each internal paddle after cleaning and prior to each use for:
  1. Nicks or burrs that may injure patient tissue
  2. Scratches, pits, or gouges in the paddle surface
  3. Loose or damaged insulating coating
  4. Cracks in the paddle's overmolded plastic

If any of these conditions are observed, remove the handle set from use.

- Autoclavable Internal Handles with Integrated Paddles are constructed from high quality materials. The severe conditions of sterilization, however, will limit their useful life. Thus, the useful life of the internal handle set is limited primarily by the frequency of sterilization rather than the age of the internal handle set.
- Inspect the Handles frequently for signs of deterioration such as cracks, crazing, damaged cables, and damaged switch covers. Replace if deterioration is noted.
- Do not clean the handles in ultrasonic cleaners. Hand or machine wash only.
- Do not expose the handles to any product containing organic solvents such as acetone, ketones, chlorinated hydrocarbons or aromatic hydrocarbons. Exposure to these solvents may degrade the handle materials.
- Keep the connector as free from contamination as possible. The connector may be immersed and cleaned with the rest of the assembly (with the cap removed), but it is difficult to clean properly because of its shape and function.
- The Connector cap must remain in place at all times to protect the contact sockets, except when in use and during cleaning.
- Repeated sterilization cycles may cause the cable insulation to blister or bubble. This is considered normal and will not affect the function of the internal handle set. Replace the internal handle set if the cable insulation is cracked or cut.

In the following sections we describe the procedures to follow for both Manual Washing and Mechanical Washing.

## MANUAL WASHING METHOD AND STERILIZATION

The handles, paddles, cable connector and connector cap must be thoroughly cleaned prior to each sterilization.

Follow this procedure for manual washing ZOLL's internal handles with integrated paddles:

1. ZOLL recommends the use of Enzol enzymatic detergent. Prepare the enzymatic detergent as recommended by the manufacturer's product labeling, e.g. solution temperature (18-22 °C, 64-71 °F) and concentration (29.57 mL to 3.79 L or 0.78% concentration). Submerge the handle set in a tub or basin sufficiently sized to accommodate the device and submerge in enzymatic detergent. Scrub with a medium-sized soft bristled brush. Soak for 5 minutes.

**Note:** It is recommended that a brush with a ½ inch (1.2 cm) diameter be used for cleaning the internal cavities.

Following the soak period, scrub the handles, paddles, cable connector, and connector cap again with a soft bristled brush. Visually inspect the handles, paddles, cable connector, and connector cap for cleanliness. If necessary, repeat the process above. The handles, paddles, cable connector, and connector cap must be free of any visible contamination prior to rinsing.

2. Rinse

Rinse the handles, paddles, cable connector, and connector cap for at least 30 seconds under running water. When rinsing the Internal Handles, be sure to rinse the cable connector, connector cap and the handle end thoroughly.

If the manufacturer of the cleaning agent recommends a rinse protocol, this should be followed.

3. Air Dry

Allow the handles, paddles, cable connector, and connector cap to air dry for 6 hours prior to wrapping for sterilization. Air drying may be performed in a drying oven whose temperature does not exceed 120° C (250° F) for a maximum duration of 30 minutes.

## Inspection

Inspect the clean handles, paddles, cable connector, and connector cap for any residual contaminants.

Inspect the internal handle set for signs of deterioration such as cracks, crazing, damaged cables, connector pins or switch covers.

Repeated sterilization cycles may cause the cable insulation to blister or bubble. This is considered normal and will not affect the function of the handle set. Replace the handle set if the cable insulation is cracked or cut.

Inspect the paddles for damaged insulating coating, or other mechanical damage such as: scratches, pits, gouges, nicks or burrs that may injure patient tissue.

If any of these conditions are observed, remove the Internal Handle Set from use.

## Securing the Connector Cap

Attach the connector cap, located on the cable of the internal handle set, securely to the cable connector (Refer to Figure 1). The connector cap must remain in place at all times to protect the contact sockets, except when in use and during cleaning.

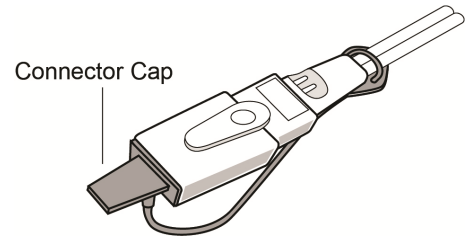

Figure 1

## Sterilization

### Steam Sterilization

**Wrap:** Before wrapping the Internal Handle with Integrated Paddles sets, be sure the cable is coiled with a diameter larger than 6 inches (15 cm). Never wrap the cables around the handles. This may hinder proper sterilization.

Wrap the internal handles and paddles in a sterile pouch according to your wrapping procedures.

**Sterilize:** Sterilize the wrapped Internal Handles with Integrated Paddles using a Pre-Vacuum Steam Autoclave. The autoclave cycles should have one of the following characteristics:

Autoclave Cycle Characteristic	Pre-Vacuum (Wrapped) Standard Cycle #1	Pre-Vacuum (Wrapped) Standard Cycle #2	Pre-Vacuum (Wrapped) Optional Long Cycle  (May be used instead of Standard Cycle)
Sterilization Temperature	132.2° – 137° C (270° – 278.6° F)	134° C – 137° C (273.2° F – 278.6° F)	132.2° – 137° C (270° – 278.6° F)
Sterilization Exposure Time	4 – 5 minutes	3 minutes, 15 seconds	18 – 20 minutes
Drying Time	10 – 12 minutes	25 minutes	20 – 30 minutes

When using hand washing, the Internal Handles with Integrated Paddles are capable of withstanding 100 steam sterilization cycles.

After sterilization, store devices in sterile wrap at room temperature until use.

### STERRAD® 100S/NX Hydrogen Peroxide Gas Plasma Sterilization Method

The Internal Handles with Integrated Paddles are capable of withstanding 100 STERRAD 100S/NX cycles.

**Wrap:** Before wrapping the Internal Handle with Integrated Paddles sets, be sure the cable is coiled with a diameter larger than 6 inches (15 cm). Never wrap the cables around the handles. This may hinder proper sterilization.

Wrap the internal handles and paddles in sterile wrapping sheets according to your wrapping procedures.

**Sterilize:** Sterilize the wrapped Internal Handles with Integrated Paddles using the STERRAD 100S or NX equipment.

When using Hand Washing, the Internal Handles with Integrated Paddles are capable of withstanding 100 STERRAD 100S/NX cycles.

ZOLL's internal handle sets are sealed to withstand up to 100 steam sterilization cycles or 100 STERRAD sterilization cycles, as specified by the following table:

STERRAD Sterilization Systems	Cycle selection
STERRAD 100S	Short
STERRAD NX	Standard

**Note:** Ensure that the Internal Handles are wrapped properly before sterilization.

## MECHANICAL WASHING METHOD AND STERILIZATION

ZOLL's internal handles with integrated paddles have been validated for mechanical washing using either the Hamo LS-1000 mechanical washer or the Getinge Series 86 Washer.

### Washer cycle parameters for the Hamo LS-100 or equivalent

Treatment	Time (mm:ss)	Temperature	Cleaning Solution (Alkaline Detergent)
Pre Wash	04:00	Cold Water (15-23° C, 59-73°F)	Neodisher FA (or equivalent)
Rinse	01:00	Cold Water (15-23° C, 59-73°F)	Not Applicable — No Cleaning Solution
Wash	11:30	50-55° C (122-135° F)	Neodisher FA (or equivalent)
Neutralize	02:00	Warm Water (32-43° C, 90-109°F)	Neodisher Z (or equivalent)
Rinse II	01:00	Warm Water (32-43° C, 90-109°F)	Not Applicable — No Cleaning Solution
Disinfect	05:00	90-95° C (194-203° F)	DI water
Dry	15:00	110° C (230° F)	Not Applicable — No Cleaning Solution

### Washer cycle parameters for the Getinge Series 86 or equivalent

Treatment	Time (mm:ss)	Temperature	Cleaning Solution (Alkaline Detergent)
Pre Wash	03:00	Cold Water (15-23° C, 59-73°F)	Not Applicable — No Cleaning Solution
Wash	05:00	>55° C (>122° F)	Steris Prolystica Alkaline (or equivalent)
Rinse	01:00	>55° C (>122° F)	DI water
Disinfect	01:00	>90° C (>194° F)	DI water
Dry	12:30	>90° C (>194° F)	Not Applicable — No Cleaning Solution

The Internal Handles with Integrated Paddles are capable of withstanding 50 mechanical washing cycles.

## Inspection

Inspect the clean handles, paddles, cable connector, and connector cap for any residual contaminants.

Inspect the internal handle set for signs of deterioration such as cracks, crazing, damaged cables, connector pins or switch covers.

Repeated sterilization cycles may cause the cable insulation to blister or bubble. This is considered normal and will not affect the function of the handle set. Replace the handle set if the cable insulation is cracked or cut.

Inspect the paddles for damaged insulating coating, or other mechanical damage such as: scratches, pits, gouges, nicks or burrs that may injure patient tissue.

If any of these conditions are observed, remove the Internal Handle Set from use.

## Securing the Connector Cap

Attach the connector cap, located on the cable of the internal handle set, securely to the cable connector (Refer to Figure 1). The connector cap must remain in place at all times to protect the contact sockets, except when in use and during cleaning.

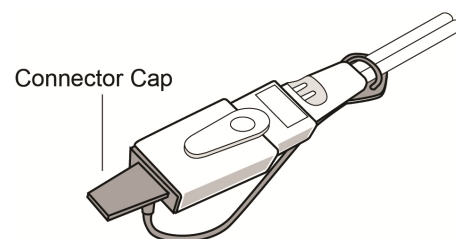

Figure 1

## Sterilization – Steam Sterilization Only

**Wrap:** Before wrapping the Internal Handle with Integrated Paddles sets, be sure the cable is coiled with a diameter larger than 6 inches (15 cm). Never wrap the cables around the handles. This may hinder proper sterilization.

Wrap the internal handles and paddles in sterile wrapping sheets according to your wrapping procedures.

**Sterilize:** Sterilize the wrapped Internal Handles with Integrated Paddles using a Pre-Vacuum Steam Autoclave. The autoclave cycles should have one of the following characteristics:

Autoclave Cycle Characteristic	Pre-Vacuum (Wrapped) Standard Cycle #1	Pre-Vacuum (Wrapped) Standard Cycle #2	Pre-Vacuum (Wrapped) Optional Long Cycle <b>(May be used instead of Standard Cycle)</b>
Sterilization Temperature	132.2° – 137° C (270° – 278.6° F)	134° C – 137° C (273.2° F – 278.6° F)	132.2° – 137° C (270° – 278.6° F)
Sterilization Exposure Time	4 – 5 minutes	3 minutes, 15 seconds	18 – 20 minutes
Drying Time	10 – 12 minutes	25 minutes	20 – 30 minutes

When using Machine Washing, the Internal Handles with Integrated Paddles are capable of withstanding 50 steam sterilization cycles.

**Note:** When using the Autoclavable Internal Handles with Integrated Paddles, REF 8011-0141-xx, with a ZOLL R Series defibrillator in a 220/240 VAC 60 Hz power environment, the internal handles can withstand a maximum of 50 steam autoclave cycles.

**WARNING**

***Do not*** use the STERRAD 100S/NX Hydrogen Peroxide Gas Plasma Sterilization Method when using the Mechanical Washing Method. The use of the STERRAD 100S/NX sterilization method after mechanical washing will damage the Internal Handles with Integrated Paddles.

When using the Mechanical Washing Method to clean the Internal Handles with Integrated Paddles, use *only* the Steam Sterilization Method.

## Selection of Appropriate Paddle Size

ZOLL's Internal Handle Sets with Integrated Paddles are offered in adult or pediatric configurations with a variety of paddle sizes (diameters). Appropriate Internal Paddle diameter for therapeutic purposes is the responsibility of the user.

Note: The internal handles with 1" diameter spoons do not comply with IEC 60601-2-4 Clause 201.15.4.101.c) for surface area recommendations for defibrillation paddles.

Caution: In order to reduce the risk of injury and to increase the likelihood of effective delivery of defibrillation, the paddle diameter selected should target as much ventricular tissue as possible, while avoiding contact outside of the ventricles.

## Verification of Operation Prior to Each Use

### WARNINGS

- ZOLL Autoclavable Internal Handles with Integrated Paddles require two qualified persons to operate, one person (**USER1**) to operate the controls on the ZOLL defibrillator and a second person (**USER2**) to position the paddles on the patient.
- Do not use ZOLL Internal Handles in the presence of flammable agents, oxygen rich atmospheres, or flammable anesthetics. Using the paddles in the presence of such agents may cause an explosion.
- Users of the handle set should assess the defibrillator's performance in their typical environment of use for the possibility of interference from high power radio or electro-surgical units. This interference may be observed as shifts in monitor baseline, trace compression, or transient spikes on the defibrillator display.
- Users of the handle set should assess the defibrillator's performance in their typical environment of use for the possibility of interference with the operation of other devices.
- Verify that no one is in contact with monitoring cables, leads, bed rails, or any other potential current pathway prior to defibrillator discharge.
- All persons nearby must be warned to *STAND CLEAR* prior to defibrillator discharge.
- When performing pre-use checks, keep hands away from the Paddles while pressing the **Shock** button.
- When verifying high voltage wiring, the paddles must be held firmly together so that the plates are not damaged.
- Inspect each paddle prior to use for:
  1. Nicks or burrs that may injure patient tissue
  2. Scratches, pits, or gouges in the paddle surface
  3. Loose or damaged insulating coating
  4. Cracks in the paddle's overmolded plasticIf you observe any of the conditions above, remove the handle set from use.
- ZOLL Medical Corporation recommends that a backup set of Autoclavable Internal Handles with Integrated Paddles be available for use in the event of a failure.

1. Inspect the connector contact sockets for damage or corrosion. If you observe damage or corrosion in the connector contact sockets, remove the handle set from use.

2. Connect the Autoclavable Internal Handles to the defibrillator and select **Defib. Mode**.
3. Verify that the **Discharge** button (Style A Handles only) does not stick.
  - a) Before charging the defibrillator, press the discharge button and verify that there is an audible click and that the button springs back upon release
  - b) Charge the defibrillator to 2 Joules. Wait for the READY tone.
  - c) During the READY tone, hold both Internal Handles and Paddles out and away from any person or object, press and hold the **Discharge** button located on one of the handles to simulate delivery of energy to the patient.
  - d) Verify that the defibrillator *does not* discharge and displays the error message, *POOR PAD CONTACT*. Occurrence of this message verifies that the **Shock** button located on the right handle is operating correctly
4. **USER1** - Press the up (▲) and down (▼) arrows of the Energy Select button located on the front panel of the unit and select 30 Joules.
5. **USER1** - Press the **Charge** button on the defibrillator front panel to charge the unit to the selected energy level. Wait for the READY Tone.
6. **USER2** - Press the Paddle surfaces firmly together.
7. Discharge the energy.
  - a) **USER2** – Style A Handles: Press and hold the **Discharge** button on the apex handle until the defibrillator delivers the selected energy to the patient (approximately 1-2 seconds).
  - b) **USER1** – Style B Handles: Press and hold the **Shock** button on the defibrillator front panel until the defibrillator delivers the selected energy to the patient (approximately 1-2 seconds).

### **WARNING**

When performing pre-use checks, keep hands away from the Paddles while pressing the shock button. See the figure on page 12 for proper handling of the ZOLL Autoclavable Internal Handles with Integrated Paddles.



## Defibrillation Procedure

### WARNINGS

Before proceeding, CAREFULLY read the following:

- Only appropriately trained and skilled personnel who are familiar with equipment operation should attempt defibrillation.
- ZOLL Autoclavable Internal Handles require two qualified persons to operate, one person (**USER1**) to operate the controls on the defibrillator and a second person (**USER2**) to position the paddles on the patient.
- Do not use ZOLL Autoclavable Internal Handles in the presence of flammable agents, oxygen rich atmospheres, or flammable anesthetics. Using the paddles in the presence of such agents may cause an explosion.
- Verify that no one is in contact with monitoring cables, leads, bed rails, or any other potential current pathway prior to defibrillator discharge.
- Do not touch the bed, patient, or any equipment connected to the patient during defibrillation.
- All persons in attendance of the patient must be warned to *STAND CLEAR* prior to defibrillator discharge.
- Do not touch the paddles together during discharge into a patient.

Review the applicable ZOLL defibrillator's Operator's Guide to become familiar with the defibrillator's operation. Note the following special instructions for use of Autoclavable Internal Handles.

1. Connect the Autoclavable Internal Handles set to the defibrillator and select **Defib. Mode**.
2. **USER1** - Press the up (▲) and down (▼) arrows of the Energy Select button located on the front panel of the defibrillator to select the desired energy. The maximum selected energy is limited to 50 Joules.
3. **USER1** - Press the **Charge** button on the defibrillator front panel to charge the unit to the selected energy level. Wait for the READY tone.
4. **USER2** – Hold the Internal Handles in the USER GRIP AREA as shown in the figure. Position the Paddles appropriately on patient's heart.
5. Discharge the Energy to the patient.
  - a. **USER2** – Style A Handles: Press and hold the **Discharge** button on the apex handle until the defibrillator delivers the selected energy to the patient (approximately 1-2 seconds).
  - b. **USER1** – Style B Handles: Press and hold the **Shock** button on the defibrillator front panel to deliver the selected energy to the patient.

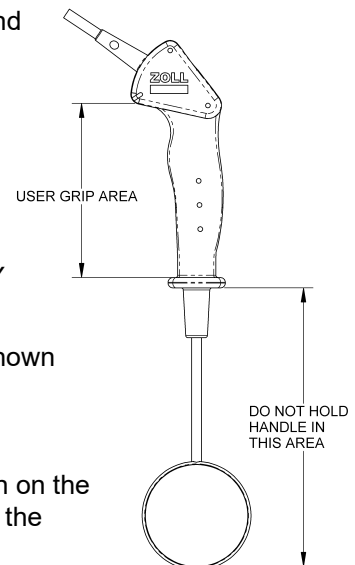

## Three-Month Checkout Procedure

To ensure quality operation of the Internal Handles perform this Checkout Procedure at least every 3 months.

## Continuity

Disconnect the handles from the defibrillator for this test.

Using an electrical continuity tester, such as a volt/ohm meter (VOM) or a digital multimeter (DMM), verify the resistance between the test points shown in the table below.

Be sure that good electrical contact is made between the test probes and the test points.

### Style A Internal Handles (Discharge Button on Handle)

Pin 5 (or Pin 1) to Right Paddle	< 1 ohm
Pin 1 (or Pin 5) to Left Paddle	< 1 ohm
Pin 2 to Pin 4 with shock button pressed (closed)	Between 2.72 and 2.88 K ohms
Pin 3 to Pin 2	Between 882 and 936 ohms

### Style B Internal Handles (No Discharge Button on Handle)

Pin 5 (or Pin 1) to Right Paddle	< 1 ohm
Pin 1 (or Pin 5) to Left Paddle	< 1 ohm
Pin 2 to Pin 3	Between 1.42 and 1.52 K ohms

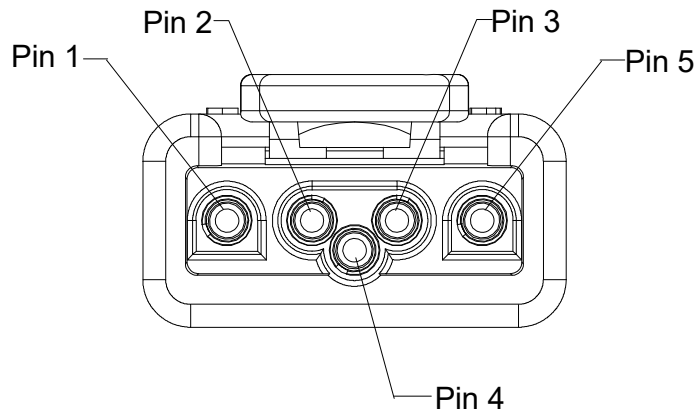

## **Leakage Currents**

Connect the internal handles set to the defibrillator. Perform a standard electrical safety leakage test. The system leakage current should not exceed 100  $\mu$ A at 110% of AC line voltage.

## **Six-Month Checkout Procedure**

When facilities are available, x-ray the cables to check for fractures or damage to the cable conductors and connectors.

## Ordering Additional Parts

Reorder numbers for the parts most frequently ordered are listed below:

REF	ITEM DESCRIPTION	ADULT	PEDIATRIC
8011-0139-01	Autoclavable Internal Handles with Switch, 100-120V Only, 1.0" [25mm] Spoon Diameter		● *
8011-0139-02	Autoclavable Internal Handles with Switch, 100-120V Only, 1.6" [40mm] Spoon Diameter		●
8011-0139-03	Autoclavable Internal Handles with Switch, 100-120V Only, 2.7" [68mm] Spoon Diameter	●	
8011-0139-04	Autoclavable Internal Handles with Switch, 100-120V Only, 3.0" [76mm] Spoon Diameter	●	
8011-0139-05	Autoclavable Internal Handles with Switch, 100-120V Only, 2.0" [51mm] Spoon Diameter		●
8011-0140-01	Autoclavable Internal Handles without Switch, 100-240V, 1.0" [25mm] Spoon Diameter		● *
8011-0140-02	Autoclavable Internal Handles without Switch, 100-240V 1.6" [40mm] Spoon Diameter		●
8011-0140-03	Autoclavable Internal Handles without Switch, 100-240V 2.7" [68mm] Spoon Diameter	●	
8011-0140-04	Autoclavable Internal Handles without Switch, 100-240V 3.0" [76mm] Spoon Diameter	●	
8011-0140-05	Autoclavable Internal Handles without Switch, 100-240V 2.0" [51mm] Spoon Diameter		●
8011-0141-01	Autoclavable Internal Handles with Switch, 7ft cable, 100-240V, 1.0" [25mm] Spoon Diameter		● *
8011-0141-02	Autoclavable Internal Handles with Switch, 7ft cable, 100-240V, 1.6" [40mm] Spoon Diameter		●
8011-0141-03	Autoclavable Internal Handles with Switch, 7ft cable, 100-240V, 2.7" [68mm] Spoon Diameter	●	
8011-0141-04	Autoclavable Internal Handles with Switch, 7ft cable, 100-240V, 3.0" [76mm] Spoon Diameter	●	
8011-0141-05	Autoclavable Internal Handles with Switch, 7ft cable, 100-240V, 2.0" [51mm] Spoon Diameter		●
9310-1006	Cap, Connector, Autoclavable		

\* See "Selection of Appropriate Paddle Size" on page 10.

Note: The internal handles with 1" diameter spoons (ZOLL part numbers 8011-0139-01, 8011-0140-01, and 8011-0141-01) have not been approved by NMPA (CFDA) to be commercialized in China.