

ZOLL®

R Series® PLUS

R Series® BLS

Operator's Guide



The issue date for the R Series Operator's Guide BLS/Plus (**REF 9650-0904-05 Rev. T**) is **August, 2024**.

Copyright © 2024 ZOLL Medical Corporation. All rights reserved.

R Series, M Series, CPR-D-padz, Pedi-padz, Pro-padz, Stat-padz, Real CPR Help, RescueNet, See-Thru CPR, Code-Ready, SurePower, OneStep, Smart Alarms, Perfusion Performance Indicator, Defib Mentor, Rectilinear Biphasic, AutoPulse, and ZOLL are trademarks or registered trademarks of ZOLL Medical Corporation in the United States and/or other countries.

Masimo is a registered trademark of Masimo Corporation in the United States and/or other countries.

All other trademarks are property of their respective owners.



ZOLL Medical Corporation

269 Mill Road
Chelmsford, MA USA
01824-4105



ZOLL International Holding B.V.

Einsteinweg 8A
6662 PW Elst
Netherlands



ZOLL Medical Switzerland AG

Baarerstrasse 8
6300 Zug
Switzerland



0123

Indication of Use

The R Series system is indicated for defibrillation on victims of cardiac arrest where there is apparent lack of circulation as indicated by:

- Unconsciousness.
- Absence of breathing.
- Absence of pulse.

The R Series system in the Manual mode is indicated for synchronized cardioversion of certain atrial or ventricular arrhythmias. A qualified physician must decide when synchronized cardioversion is appropriate.

The R Series system Semiautomatic and Manual mode is indicated for use in early defibrillation programs where the delivery of a defibrillator shock during resuscitation involving CPR, transportation, and definitive care are incorporated into a medically-approved patient care protocol.

The R Series system Semiautomatic and Manual mode is indicated for adult and pediatric patients.

ECG Monitoring

The R Series system is indicated to evaluate the patient's heart rate or ECG morphology via ECG monitoring. In ECG monitoring mode, the feature is indicated for use by personnel who are qualified by training in the use of the R Series defibrillator, basic life and/or advanced life support, or other physician-authorized emergency medical training.

Real CPR Help

The R Series system is indicated to provide visual and audio feedback via the CPR Help feature, which is designed to encourage rescuers to perform chest compressions at the AHA/ERC recommended depth and rate of 2 inches (5 cm) and 100 compressions per minute.

External Pacemaker

The R Series system is indicated for temporary external cardiac pacing in conscious or unconscious patients as an alternative to endocardial stimulation. External Pacing is indicated for pediatric and adult patients.

SpO₂ Monitoring

The R Series system is indicated for the continuous, noninvasive monitoring of arterial oxygen saturation (SpO₂) and pulse rate during both no motion and patient motion conditions for adult patients, and no motion conditions for pediatric and neonatal patients in a hospital or prehospital environment.

EtCO₂ Monitoring

The R Series system is indicated for the continuous noninvasive monitoring of end tidal carbon dioxide (EtCO₂) and respiration rate in patients requiring ventilator support, in-hospital transport, or anesthesia. EtCO₂ Monitoring is indicated for in patients from newborn (neonate) to adult.

Non-Invasive Blood Pressure Monitoring (NIBP)

The R Series system is indicated for the non-invasive measurement of arterial blood pressure for resting patients in critical care and in-hospital transport. The NIBP feature is indicated to measure blood pressure for patients from newborn (neonate) to adult.

CONTRAINDICATIONS

The R Series Semiautomatic Operation Contraindications for Use

The rhythm analysis function may not reliably identify ventricular fibrillation in the presence of an implanted pacemaker. Inspection of the electrocardiogram and clinical evidence of cardiopulmonary arrest should be the basis for any treatment of patients with implanted pacemakers. Do not use the rhythm analysis function during patient movement on a stretcher. A patient must be motionless during ECG analysis. Do not touch the patient during analysis. Cease all movement of the stretcher prior to analyzing the ECG.

General Information

Federal (U.S.A.) law restricts this defibrillator to sale by or on the order of a physician.

Table of Contents

Indication of Use	iii
ECG Monitoring	iii
Real CPR Help	iii
External Pacemaker	iii
SpO ₂ Monitoring	iii
EtCO ₂ Monitoring	iii
Non-Invasive Blood Pressure Monitoring (NIBP)	iii
CONTRAINDICATIONS	iv
General Information	iv

Chapter 1 General Information

Product Description	1-1
R Series Model Features	1-3
How to Use This Manual.....	1-4
Operator's Guide Updates	1-4
Unpacking.....	1-4
Symbols Used on the Equipment	1-4
Conventions.....	1-7
Defibrillator Function	1-8
Intended Purpose	1-8
Intended Use — Manual Operation	1-8
Intended Use — Semiautomatic Operation (AED)	1-9
Intended Use — ECG Monitoring	1-9
Intended Use — Real CPR Help	1-9
Semiautomatic Operation Contraindications for Use	1-9
Defibrillator Complications	1-10
Defibrillator Output Energy	1-10
External Pacemaker (Optional).....	1-10
Intended Use — Pacemaker	1-10
Pacemaker Complications	1-11
Pediatric Pacing	1-12
Intended Use — SpO ₂ Monitoring	1-12
Intended Use — EtCO ₂ Monitoring.....	1-12
Intended Use — NIBP.....	1-13
ECG Monitoring	1-14
Recorder Function (Manual Mode Only).....	1-14
Paddles and Electrodes.....	1-14
Batteries.....	1-15
Code-Ready System.....	1-16
Safety Considerations.....	1-16
Warnings.....	1-16
Operator Safety	1-18
Patient Safety	1-19

Cautions.....	1-20
Restarting the Defibrillator	1-21
FDA Tracking Requirements.....	1-21
Notification of Adverse Events	1-22
Software License	1-22
Service.....	1-23
The ZOLL Serial Number.....	1-24

Chapter 2 Product Overview

Defibrillator Controls and Indicators.....	2-1
The Front Panel	2-3
Display Screen	2-6
Patient Cables and Connectors	2-8
External Paddles (Manual Mode Only)	2-10
Working with Menus (Manual Mode Only).....	2-12
Common Tasks	2-13
Replacing a Battery Pack	2-13
Adjusting Display Brightness (Manual Mode Only)	2-14
Using Code Markers (Manual Mode Only)	2-14

Chapter 3 Automated External Defibrillator (AED) Operation

AED Operation.....	3-2
Determine Patient Condition Following Medical Protocols	3-2
Begin CPR Following Medical Protocols	3-2
Prepare Patient	3-2
1 Select ON	3-4
2 Analyze	3-5
3 Press SHOCK	3-6
Operating Messages	3-8
Audio and Display Messages	3-8
Switching to Manual Mode Operation.....	3-10

Chapter 4 Manual Defibrillation

Emergency Defibrillation Procedure with Paddles.....	4-1
Determine the Patient’s Condition Following Local Medical Protocols	4-1
Begin CPR Following Local Medical Protocols	4-2
1 Select ON	4-2
2 Charge Defibrillator	4-4
3 Deliver Shock	4-5
Autoclavable External Paddles	4-6
Emergency Defibrillation Procedure with Hands-Free Therapy Electrodes.....	4-7
Determine the Patient’s Condition Following Local Medical Protocols	4-7
Begin CPR Following Medical Protocols	4-7
Prepare Patient	4-7
1 Select ON	4-9
2 Charge Defibrillator	4-10

3 Deliver Shock	4-11
Autoclavable Electrodes	4-12

Chapter 5 Advisory Defibrillation

Advisory Defibrillation Procedure	5-2
Determine the Patient's Condition Following Local Medical Protocols	5-2
Begin CPR Following Local Medical Protocols	5-2
Prepare Patient	5-2
1 Select ON	5-2
2 Press ANALYZE Button	5-4
3 Press SHOCK	5-5
Advisory Function Messages	5-7
Warning Messages	5-7

Chapter 6 Synchronized Cardioversion

Synchronized Cardioversion Procedure	6-2
Determine the Patient's Condition and Provide Care Following Local Medical Protocols	6-2
Prepare Patient	6-2
1 Select ON	6-3
2 Charge Defibrillator	6-4
3 Deliver SHOCK	6-5
Remote Synchronized Cardioversion Procedure	6-5
Determine the Patient's Condition and Provide Care Following Local Medical Protocols	6-6
Prepare Patient	6-6
1 Select ON	6-6
2 Charge Defibrillator	6-7
3 Deliver SHOCK	6-7

Chapter 7 Real CPR Help

Real CPR Help Field	7-2
Perfusion Performance Indicator (R Series Plus/Adult Only)	7-2
CPR Idle Time Display	7-2
CPR Rate and Depth Display	7-2
Compression Release Bar (R Series Plus/Adult only)	7-3
CPR Metronome	7-3
Fully Release prompt	7-4
CPR Voice Prompts (R Series Plus/Adult only)	7-4
Chest Compressions Bar Graph (Manual Mode Only)	7-4
Displaying the CPR Bar Graph (Manual Mode Only)	7-4

Chapter 8 See-Thru CPR (R Series Plus Only)

Using See-Thru CPR (R Series Plus Only)	8-2
Examples	8-2

Chapter 9 Noninvasive Temporary Pacing (Optional)

Noninvasive Temporary Pacing	9-2
Determine Patient Condition and Provide Care Following Local Medical Protocols ...	9-2
Prepare the Patient	9-2
1 Apply ECG Electrodes/Hands-Free Therapy Electrodes	9-2
1 Select ON	9-3
2 Turn Mode Selector to PACER	9-4
3 Set Pacer Rate	9-4
4 Set Pacer Output	9-5
5 Determine Capture	9-5
6 Determine Optimum Threshold	9-6
Special Pacing Applications	9-8
Standby Pacing	9-8
Asynchronous (Fixed) Pacing	9-8
1 Select ON	9-9
2 Turn Mode Selector to PACER	9-9
Press the Async (Fixed) Pacing On/Off softkey	9-10
Pediatric Pacing	9-10

Chapter 10 ECG Monitoring

Preparations	10-2
Electrode Placement.....	10-2
Monitoring Electrodes Attachment	10-3
Monitoring the Patient's ECG	10-4
Set the Controls	10-4
Implanted Pacemakers	10-5
5-Lead Monitoring.....	10-7
Simultaneous 3-Lead Printing	10-7
See-Thru CPR Filter (R Series Plus Only)	10-7
Adding Traces to Be Displayed	10-8
Printing the ECG on a Stripchart	10-8
Diagnostic Bandwidth	10-8
Alarms.....	10-9
Setting Alarm Limits	10-9
Heart Rate Alarm Limits	10-10
Vital Sign Alarms	10-10
Suspending and Silencing Alarms	10-10
Smart Alarms	10-11
Alarm Settings for Unattended Monitoring	10-12

Chapter 11 Event Records and Reports

Summary Report.....	11-1
Summary Report Formats	11-2
Printing the Entire Summary Report	11-8
Printing a Partial Summary Report	11-9
Full Disclosure Recording.....	11-9

Incident Logs	11-9
Printing an Incident Log	11-9
Erasing Summary Report and Full Disclosure	11-10
Manual Erasure	11-10
Automatic Erasure	11-10
Formatting the Disk	11-10
Related Messages	11-11

Chapter 12 File Transfer

Transferring Files to an External Device	12-1
Wi-Fi (Optional).....	12-2
Installing or Removing a Compact Flash Card	12-2
Transferring a Full Disclosure File to a Compact Flash Card	12-3
Transferring Device Check and Activity Log Files to a Compact Flash Card.....	12-4
Transferring Files Through the USB Port (R Series Plus Only)	12-4
Transferring Full Disclosure Files Through Wi-Fi (R Series Plus Only)	12-5
Transferring Device Check and Activity Log Files Through Wi-Fi (R Series Plus Only) ...	12-6
Related Wi-Fi Messages	12-8

Chapter 13 Maintenance

Routine Procedures	13-2
Daily Visual Inspection	13-2
Code Readiness Test	13-3
Manual Defibrillator Testing.....	13-3
Defibrillator Testing with Paddles	13-4
Defibrillator Testing with Hands-Free Therapy Electrodes	13-5
Pacer Testing	13-6
Recorder Check	13-6
Code Readiness Log	13-7
Setting Time and Date	13-8
Cleaning the R Series Unit	13-9
Loading Stripchart Paper	13-10
Cleaning the Print Head	13-11
Operator's Checklist for R Series Product	13-12

Chapter 14 Troubleshooting

Code-Ready	14-1
Monitor	14-2
Recorder	14-4
Pacer	14-4
Defibrillator	14-5
AC Charger	14-8
CPR	14-8

Appendix A Specifications

Defibrillator Specifications	A-2
Battery Pack Specifications	A-8
IEC 60601-1-2 Specifications	A-8
Electromagnetic Emissions Declaration	A-8
Electromagnetic Immunity Declaration (EID)	A-9
Electromagnetic Immunity	A-10
Recommended Separation Distances from RF Equipment for the R Series Functions	A-12
R Series Rectilinear Biphasic Waveform Characteristics	A-13
Clinical Trial Results for the Biphasic Waveform	A-25
Randomized Multicenter Clinical Trial for Defibrillation of Ventricular Fibrillation (VF) and Ventricular Tachycardia (VT)	A-25
Pre-Clinical Study	A-26
Published Clinical Data	A-27
Randomized Multi-Center Clinical trial for Cardioversion of Atrial Fibrillation (AF) ...	A-27
Synchronized Cardioversion of Atrial Fibrillation	A-29
ECG Rhythm Analysis Algorithm Accuracy	A-30

Appendix B R Series Accessories

Appendix C Wi-Fi Radio Module Information

Chapter 1

General Information

Product Description

The ZOLL® R Series® products combine a defibrillator, ECG display, advanced monitoring capabilities, and Noninvasive Transcutaneous Pacing (NTP) with communication, data printing and recording capabilities in a single lightweight portable instrument. The unit has been designed for all resuscitation situations and its small, compact, lightweight design makes it ideal for accompanying patients during transport. The product is powered by AC mains and an easily replaced battery pack that is quickly recharged in the device when it is connected to AC mains. In addition, the unit's battery may be recharged and tested using a ZOLL SurePower™ Battery Charger.

The product is designed for use in the hospital. All of its ruggedized features add to its durability in hospital applications.

The R Series comes in both R Series Plus and R Series BLS models. This guide documents all the features that are available in both models. Both models can also have the additional optional features of Pacing and SpO₂.

The BLS model does not contain all of the functions that are included in the Plus model. The features that only apply to the Plus model are documented as *R Series Plus Only* within the manual, and optional features are documented as *Optional*.

Refer to the table on page 1-3 for a listing of features that are available in the R Series defibrillator models.

The R Series is a versatile external defibrillator. The device powers up in AED mode automatically. Depending on local protocols, the device may start prompting the operator to *PERFORM CPR* or the device may start analyzing ECG automatically, prompt the operator to *STAND CLEAR*, charge the defibrillator (if appropriate), and prompt the operator to *PRESS SHOCK* in between periods of CPR. The device can be switched to Manual mode after power

up. When operating in the manual configuration, the device operates as a conventional defibrillator where the device's charging and discharging are fully controlled by the operator. In advisory mode, some of the features of the device are automated and a sophisticated algorithm is used to identify shockable ECG rhythms (VF and wide complex VT >150 bpm) that should be treated by defibrillator shock delivery. Depending on local protocols, the unit may be configured to automatically analyze the ECG, charge the defibrillator (if appropriate), and prompt the operator to *PRESS SHOCK* between periods of CPR.

The R Series unit assists caregivers during cardiopulmonary resuscitation (CPR) by evaluating the rate and depth of chest compressions and providing feedback to the rescuer.

Real CPR Help[®] requires the use of OneStep[™] CPR electrodes or OneStep Complete electrodes. When using these pads, the displayed ECG waveforms can be adaptively filtered, using the See-Thru CPR[®] feature, to reduce the artifact caused by chest compressions.

The R Series is a Code-Ready[®] defibrillator. It extends testing beyond shock delivery and checks more than 40 measures of readiness, including the presence of the correct cables and electrodes, the type of electrode, and other important electronic functions. The R Series also verifies the condition and expiration date of OneStep electrodes. This code readiness testing can occur automatically, without disconnecting electrodes or paddles, or requiring additional equipment to test shock delivery. The system also provides a printed, or electronic log to alert hospital personnel of any defibrillator functions or accessories that are compromised in advance of a code.

Some R Series models include an optional transcutaneous pacemaker consisting of a pulse generator and ECG sensing circuitry. The pacing option supports both synchronous (demand) and asynchronous (fixed) noninvasive pacing for adult, pediatric, or neonatal patients. OneStep Pacing electrodes and OneStep Complete electrodes allow demand pacing and ECG monitoring without separate ECG electrodes when the R Series is used with the OneStep Pacing cable.

Information regarding the unit's operation, ECG, and other physiological waveforms are displayed on a large 6.5 inch (16.5 cm) diagonal display which provides high contrast and visibility under virtually all lighting conditions. Operating and warning messages are displayed on the monitor, and the unit can also be configured with voice prompts to alert the user to unit status. The R Series performs code readiness testing when the unit is OFF but connected to AC power, when the defibrillator is initially turned on, and periodically during operation.

An annotating strip chart recorder is included to provide immediate documentation as well as summary report functions about patient care and treatment in Manual mode.

A sophisticated data collection system, including summary report, printer, and multiple communication ports is available for this unit. The stored data can be reviewed and archived on a properly equipped personal computer using ZOLL RescueNet[®] software. R Series data files may be transferred to a PC using USB, Compact Flash cards or Wi-Fi.

R Series products are intended for use in either AED mode or Manual mode by personnel certified by appropriate federal, state, or local government authority to provide advanced life support care.

R Series Model Features

The following features are available in the R Series Plus and R Series BLS models. Pacing and SpO2 monitoring are additional options that may be purchased separately.

Feature	BLS Model	Plus Model
Real CPR Help	✓	✓
See-Thru CPR		✓
Perfusion Performance Indicator™		✓
OneStep system	✓	✓
OneStep cable	✓	✓
OneStep ECG leads cable (3-lead set)		✓
OneStep Cable Manager		✓
Code Readiness testing system	✓	✓
Integrated hands free electrode mounting	✓	✓
Rectilinear Biphasic Waveform	✓	✓
Universal operating system	✓	✓
Defib activity log	✓	✓
Corrective voice prompts		✓
5.8 Ah rechargeable lithium-ion battery	✓	✓
3 lead ECG cable	✓	✓
90mm strip chart writer	✓	✓
Integrated AC power	✓	✓
Built-in test port	✓	✓
Compact Flash card slot	✓	✓
USB device port		✓
Wi-Fi communication software		✓
EtCO ₂		✓
NIBP		✓
Optional Items Available in Both Models		
Pacing		
SpO2		

How to Use This Manual

The R Series Operator's Guide provides information operators need for the safe and effective use and care of the R Series products. It is important that all persons using this device read and understand all the information contained within.

Please read thoroughly the safety considerations and warnings section.

Procedures for daily checkout and unit care are located in "Maintenance" on page 13-1.

This manual is supplemented by manual inserts for options available on the R Series. These inserts contain additional warnings, precautions, and safety-related information.

Operator's Guide Updates

An issue or revision date for this manual is shown on the front cover. If more than three years have elapsed since this date, contact ZOLL Medical Corporation to determine if additional product information updates are available.

All users should carefully review each manual update to understand its significance and then file it in its appropriate section within this manual for subsequent reference.



Product documentation is available through the ZOLL website at www.zoll.com. From the Products menu, choose Product Manuals.















Unpacking





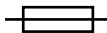









Carefully inspect each container for damage. If the shipping container or cushion material is damaged, keep it until the contents have been checked for completeness and the instrument has been checked for mechanical and electrical integrity. If the contents are incomplete, if there is mechanical damage, or if the defibrillator does not pass its electrical self-test, U.S.A. customers should call ZOLL Medical Corporation (1-800-348-9011). Customers outside of the U.S.A. should contact the nearest ZOLL authorized representative. If the shipping container is damaged, also notify the carrier.









Symbols Used on the Equipment

Any or all of the following symbols may be used in this manual or on this equipment:

Symbol	Description
	Dangerous voltage.
	MR unsafe: keep away from magnetic resonance imaging equipment
	Attention, consult accompanying documents.

Symbol	Description
	Fragile, handle with care.
	Keep dry.
	This end up.
	Temperature limitation.
	Conformité Européenne Complies with medical device directive 93/42/EEC.
	Type B patient connection.
	Type BF patient connection.
	Type CF patient connection.
	Defibrillator-proof type BF patient connection.
	Defibrillator-proof type CF patient connection.
	Fusible link.
	Equipotentiality.
	Alternating current (AC).
	Direct current (DC).

Symbol	Description
	Contains lithium. Recycle or dispose of properly.
	Keep away from open flame and high heat.
	Do not open, disassemble, or intentionally damage.
	Do not crush.
	Do not discard in trash. Recycle or dispose of properly.
	Return to a collection site intended for waste electrical and electronic equipment (WEEE). Do not dispose of in unsorted trash.
	Date of manufacture.
	Use by.
	Latex-free.
	Do not reuse.
	Do not fold.
	Not sterile.
	Nonionizing electromagnetic radiation from Wi-Fi during data transfer.
	Manufacturer.

Symbol	Description
	Authorized representative in the European Community.
	Serial Number.
	Catalogue number.
	Consult instructions for use.
Rx ONLY	Prescription only.
$E_{MAX} = 200J$	Maximum energy.
Test at 30 J. 	Test port.
	Indicates a carrier that contains Unique Device Identifier information.
	Indicates the item is a medical device.
	Indicates the entity importing the medical device into the locale.
	Indicates the authorized representative in Switzerland.

Conventions

This guide uses the following conventions:

Within text, the names and labels for physical buttons and softkeys appear in **boldface** type (for example, “Press the **SHOCK** button or the **Code Marker** softkey”).

This guide uses uppercase italics for audible prompts and for text messages displayed on the screen (for example, *CHECK PATIENT*).

WARNING! Warning statements alert you to conditions or actions that can result in personal injury or death.

Caution Caution statements alert you to conditions or actions that can result in damage to the unit.

Defibrillator Function

The R Series product contains a direct current (DC) defibrillator capable of delivering up to 200 joules. It may be used in synchronized mode to perform synchronized cardioversion using the patient's R-wave as a timing reference. The unit uses paddles or disposable, pregelled electrodes for defibrillation.

Intended Purpose

The intended purpose of the R Series products is for qualified medical professionals to use the device to help adult, pediatric, and neonatal patients experiencing symptoms of sudden cardiac arrest. The R Series devices are portable defibrillators that combine defibrillation and external pacing with the following monitoring capabilities: ECG, EtCO₂, SpO₂, non-invasive blood pressure, and Real CPR Help, when using compatible electrodes and sensors.

The R Series devices have optional features that can be configured to meet the needs of a particular application and can be configured to operate in manual, advisory, or AED modes. In advisory and AED modes, some of the device's features are automated and an ECG detection algorithm is used to analyze a patient's presenting rhythm and determine the appropriateness of defibrillation shock. Units may be configured to automatically charge, analyze, recharge, and prompt the operator to *PRESS SHOCK*, depending on local protocols. The unit is switched from AED mode to manual mode for advanced cardiac life support use by pressing the appropriate key on the front panel. When operating in manual configuration, the device operates as a conventional defibrillator where the device's charging and discharging is fully controlled by the operator. In manual mode, the device may also be used to perform synchronized cardioversion using the patient's R-wave as a timing reference.

Intended Use — Manual Operation

Use of the R Series products in the manual mode for defibrillation is indicated on victims of cardiac arrest where there is apparent lack of circulation as indicated by:

- Unconsciousness.
- Absence of breathing.
- Absence of pulse.

This product should be used only by qualified medical personnel for converting ventricular fibrillation and rapid ventricular tachycardia to sinus rhythm or other cardiac rhythms capable of producing hemodynamically significant heart beats.

In manual mode, the unit can also be used for synchronized cardioversion of certain atrial or ventricular arrhythmias. A qualified physician must decide when synchronized cardioversion is appropriate.

The advisory function should be used to confirm ventricular fibrillation or wide complex ventricular tachycardia (greater than 150 beats per minute) in patients meeting the three conditions indicating lack of circulation (listed above).

Intended Use — Semiautomatic Operation (AED)

R Series products are designed for use by emergency care personnel who have completed training and certification requirements applicable to the use of a defibrillator where the device operator controls delivery of shocks to the patient.

They are specifically designed for use in early defibrillation programs where the delivery of a defibrillator shock during resuscitation involving CPR, transportation, and definitive care are incorporated into a medically-approved patient care protocol.

Use of the R Series in the Semiautomatic mode for defibrillation is indicated on victims of cardiac arrest where there is apparent lack of circulation as indicated by:

- Unconsciousness.
- Absence of breathing.
- Absence of pulse.

Specifications for the ECG rhythm analysis function are provided in the section, “ECG Rhythm Analysis Algorithm Accuracy” on page A-30.

When the patient is less than 8 years of age or weighs less than 55 lbs. (25 Kg), you must use ZOLL pediatric defibrillation electrodes. Do not delay therapy to determine patient’s exact age or weight.

Intended Use — ECG Monitoring

The unit is intended for use when ECG monitoring is indicated to evaluate the patient’s heart rate or ECG morphology. In ECG monitoring mode, the unit is intended to be used by personnel who are qualified by training in the use of the R Series defibrillator, basic life and/or advanced life support, or other physician-authorized emergency medical training.

Intended Use — Real CPR Help

The Real CPR Help function provides visual and audio feedback designed to encourage rescuers to perform chest compressions at the AHA/ERC recommended rate of 100 - 120 compressions per minute. Voice and visual prompts encourage a compression depth in accordance with AHA and/or ERC recommendations of 2 inches (5 cm) minimum for adult patients.

Semiautomatic Operation Contraindications for Use

The rhythm analysis function may not reliably identify ventricular fibrillation in the presence of an implanted pacemaker. Inspection of the electrocardiogram and clinical evidence of cardiopulmonary arrest should be the basis for any treatment of patients with implanted pacemakers.

Do not use the rhythm analysis function during patient movement on a stretcher or in an ambulance or other conveyance. A patient must be motionless during ECG analysis. Do not touch the patient during analysis. Cease all movement of the stretcher or vehicle prior to analyzing the ECG. If you are using the R Series in an emergency vehicle, bring the vehicle to a halt before activating the analysis function.

Defibrillator Complications

Inappropriate defibrillation or cardioversion of a patient (for example, with no malignant arrhythmia) may precipitate ventricular fibrillation, asystole, or other dangerous arrhythmias.

Defibrillation without proper application of electrodes or paddle electrolyte gel might be ineffective and cause burns, particularly when repeated shocks are necessary. Erythema or hyperemia of the skin under the paddles, or electrodes often occurs; this effect is usually enhanced along the perimeter of the paddles or electrodes. This reddening should diminish substantially within 72 hours.

Defibrillator Output Energy

R Series defibrillators can deliver as much as 200 joules into a 50 ohm impedance. The energy delivered through the chest wall, however, is determined by the patient's transthoracic impedance. An adequate amount of electrolyte gel must be applied to the paddles and a force of 10 to 12 kilograms (22 to 26.4 pounds) must be applied to each paddle in order to minimize this impedance. If hands-free therapy electrodes are used, make sure that they are properly applied. (Refer to the instructions on the electrode package).

External Pacemaker (Optional)

Some R Series products include an optional transcutaneous pacemaker consisting of a pulse generator and ECG-sensing circuitry. Noninvasive transcutaneous pacing (NTP) is an established and proven technique. This therapy is easily and rapidly applied in both emergency and nonemergency situations when temporary cardiac stimulation is indicated.

The output current of the pacemaker is continuously variable from 0 to 140 mA. The rate is continuously variable from 30 to 180 pulses per minute (ppm), by increments of 2.

The pacing output pulse is delivered to the heart via ZOLL hands-free defibrillation/pacing electrodes placed on the patient's back and the precordium.

The characteristics of the output pulse, together with the design and placement of the electrodes, minimize cutaneous nerve stimulation, cardiac stimulation threshold currents, and reduce discomfort due to skeletal muscle contraction.

The unique design of the R Series products allow clear viewing and interpretation of the electrocardiogram on the display without offset or distortion during external pacing.

Proper operation of the device, together with correct electrode placement, is critical to obtaining optimal results. Every operator must be thoroughly familiar with these operating instructions.

Intended Use — Pacemaker

This product can be used for temporary external cardiac pacing in conscious or unconscious patients as an alternative to endocardial stimulation.

The purposes of pacing include:

- Resuscitation from standstill or bradycardia of any etiology.

Noninvasive pacing has been used for resuscitation from cardiac standstill, reflex vagal standstill, drug-induced standstill (due to procainamide, quinidine, digitalis, b-blockers, verapamil, etc.) and unexpected circulatory arrest (due to anesthesia, surgery, angiography, and other therapeutic or diagnostic procedures). It has also been used for temporary acceleration of bradycardia in Stokes-Adams disease and sick-sinus syndrome. It is safer, more reliable, and more rapidly applied in an emergency than endocardial or other temporary electrodes.

- As a standby when standstill or bradycardia might be expected.

Noninvasive pacing can be useful as a standby when cardiac arrest or symptomatic bradycardia might be expected due to acute myocardial infarction, drug toxicity, anesthesia, or surgery. It is also useful as a temporary treatment in patients awaiting pacemaker implants or the introduction of transvenous therapy. In standby pacing applications, noninvasive pacing might provide an alternative to transvenous therapy that avoids the risks of displacement, infection, hemorrhage, embolization, perforation, phlebitis, and mechanical or electrical stimulation of ventricular tachycardia or fibrillation associated with endocardial pacing.

- Suppression of tachycardia.

Increased heart rates in response to external pacing often suppress ventricular ectopic activity and might prevent tachycardia.

WARNING! This device can only be used for external pacing of patients and cannot be used for internal pacing. Do not connect internal pacing lead wires to the ZOLL defibrillator.

Pacemaker Contraindications for Use

There are no known contraindications for the use of the pacemaker.

Pacemaker Complications

Ventricular fibrillation does not respond to pacing and requires immediate defibrillation. Therefore, the patient's dysrhythmia must be determined immediately, so that you can employ appropriate therapy. If the patient is in ventricular fibrillation and defibrillation is successful but cardiac standstill (asystole) ensues, you should use the pacemaker.

Ventricular or supraventricular tachycardias can be interrupted with pacing, but in an emergency or during circulatory collapse, synchronized cardioversion is faster and more certain.

Pulseless electrical activity (PEA) can occur following prolonged cardiac arrest or in other disease states with myocardial depression. Pacing might then produce ECG responses without effective mechanical contractions, making other effective treatment necessary.

Pacing can evoke undesirable repetitive responses, tachycardia, or fibrillation in the presence of generalized hypoxia, myocardial ischemia, cardiac drug toxicity, electrolyte imbalance, or other cardiac diseases.

Pacing by any method tends to inhibit intrinsic rhythmicity. Abrupt cessation of pacing, particularly at rapid rates, can cause ventricular standstill and should be avoided.

Noninvasive temporary pacing can cause discomfort of varying intensity, which occasionally can be severe and preclude its continued use in conscious patients.

Similarly, unavoidable skeletal muscle contraction might be troublesome in very sick patients and might limit continuous use to a few hours. Erythema or hyperemia of the skin under the hands-free therapy electrodes often occurs; this effect is usually enhanced along the perimeter of the electrode. This reddening should lessen substantially within 72 hours.

There have been reports of burns under the anterior electrode when pacing adult patients with severely restricted blood flow to the skin. Prolonged pacing should be avoided in these cases and periodic inspection of the underlying skin is advised.

There are reports of transient inhibition of spontaneous respiration in unconscious patients with previously available units when the anterior electrode was placed too low on the abdomen.

WARNING! This device can only be used for external pacing of patients and cannot be used for internal pacing. Do not connect internal pacing lead wires to the ZOLL defibrillator.

Pediatric Pacing

Pacing can be performed on pediatric patients weighing 55 lb. (25 kg) or less using ZOLL pediatric hands-free therapy electrodes. Prolonged pacing (in excess of 30 minutes), particularly in neonates, can cause burns. Periodic inspection of the underlying skin is recommended.

Intended Use — SpO₂ Monitoring

The R Series pulse oximeter, with the Masimo[®] SET[®] technology and the LNCS[®] series of oximeter sensors, is indicated for the continuous, noninvasive monitoring of arterial oxygen saturation (SpO₂) and pulse rate during both no motion and patient motion conditions for adult patients, and no motion conditions for pediatric and neonatal patients in a hospital or prehospital environment.

SpO₂ Contraindications for Use

See the *R Series Pulse Oximetry (SpO₂)* insert (ZOLL part number 9650-0901-01) for disclosures of any contraindications for use of the pulse oximeter monitoring feature.

Intended Use — EtCO₂ Monitoring

The ZOLL R Series EtCO₂ option with Respirationics Novametrix technology is indicated for the continuous noninvasive monitoring of end tidal carbon dioxide (EtCO₂) and respiration rate in patients requiring ventilator support, in-hospital transport, or anesthesia. The R Series EtCO₂ option with Respirationics Novametrix technology supports two methods for continuous measurement of end tidal carbon dioxide (EtCO₂) and respiration rate.

The first method uses the CAPNOSTAT 5 Mainstream CO₂ sensor attached to an airway adapter that connects to an endotracheal tube, mask or disposable mouthpiece.

The second method uses the LoFlo CO₂ module to monitor both non-intubated and intubated patients using specially designed sampling cannulas and airway adapters.

The R Series EtCO₂ option is designed to monitor adult, pediatric, and neonatal patients.

The following substances can influence CO₂ measurements made with the CAPNOSTAT 5 CO₂ sensor or the LoFlo sidestream module:

- elevated oxygen levels
- nitrous oxide
- halogenated agents

The R Series EtCO₂ option provides settings for high oxygen and/or nitrous oxide compensation. Halogenated anesthetic agents alter CO₂ readings, but the R Series unit will monitor CO₂ within specifications when these agents are present at normal clinical levels. The presence of Desflurane in the exhaled breath beyond normal values (5%) may positively bias measured carbon dioxide values by up to an additional 3 mmHg.

The R Series EtCO₂ option is intended for use only with the ZOLL/Respironics Novamatrix CAPNOSTAT 5 Mainstream CO₂ Sensor and mainstream airway adapters, the LoFlo CO₂ Module, nasal and nasal/oral sampling cannula sets, and sidestream on-airway adapters.

The R Series EtCO₂ option can be used on adult patients (21 years of age and older) and on pediatric patients, as described in the following table:

Pediatric Subpopulation	Approximate Age Range
Newborn (neonate)	Birth to 1 month of age
Infant	1 month to 2 years of age
Child	2 to 12 years of age
Adolescent	12-21 years of age

EtCO₂ Contraindications for Use

See the *R Series End Tidal Carbon Dioxide (EtCO₂)* insert (ZOLL part number 9650-0915-01) for disclosures of any contraindications for use of the EtCO₂ monitoring feature.

Intended Use — NIBP

The ZOLL R Series NIBP option is indicated for the non-invasive measurement of arterial blood pressure for resting patients in critical care and in-hospital transport.

The R Series NIBP option is designed to measure blood pressure for adult patients (21 years of age and older) and for pediatric patients, as described in the following table:

Pediatric Subpopulation	Approximate Age Range
Newborn (neonate)	Birth to 1 month of age
Infant	1 month to 2 years of age
Child	2 to 12 years of age
Adolescent	12-21 years of age

NIBP Contraindications for Use

See the *R Series Non-Invasive Blood Pressure (NIBP)* insert (ZOLL part number 9650-0914-01) for disclosures of any contraindications for use of the NIBP monitoring feature.

ECG Monitoring

The patient's ECG is monitored by connecting the patient to the unit via a 3- or 5-lead patient cable, hands-free therapy electrodes, or through paddles. Five seconds of ECG is presented on the display along with the following information:

- averaged heart rate, derived by measuring R to R intervals
- lead selection - I, II, III, aVR, aVL, aVF, V (with ECG cable), PADDLES or PADS, P1, P2, P3 (when using OneStep Pacing cable with OneStep Complete electrodes).

P1, P2, and P3 are non-standard ECG leads derived from electrodes within particular OneStep electrodes. While ECG signals acquired from these leads are appropriate for rhythm assessment and determining electrical capture during pacing, they should not be used for ECG morphological evaluation. Attach conventional ECG electrodes for diagnostic purposes.

- ECG size relative scale factor - x0.5, x1, x1.5, x2, x3
- other operational prompts, messages, and diagnostic codes

Monitoring or diagnostic ECG bandwidth is selectable.

Recorder Function (Manual Mode Only)

The strip recorder is provided to document events in Manual mode. The strip recorder normally operates in the delay mode (6 seconds) to ensure the capture of ECG information immediately preceding critical events. The recorder may be activated manually by pressing the **RECORDER** button. It is activated automatically whenever a defibrillation **SHOCK** is delivered, a heart rate alarm occurs, or the rhythm analysis function is activated. The strip recorder may also be configured not to print during these events.

Paddles and Electrodes

In AED mode, the R Series will defibrillate, cardiovert, and monitor ECG using only hands-free therapy electrodes. In Manual mode, the R Series will defibrillate, cardiovert, and monitor ECG using either defibrillation paddles or hands-free therapy electrodes.

The pacer version of the R Series will pace using ZOLL hands-free therapy electrodes.

ENERGY SELECT, **CHARGE** and **SHOCK** controls are located on the paddles and front panel. When using hands-free therapy electrodes, you must use the controls on the front panel of the unit. To switch between paddles and hands-free therapy electrodes, remove the OneStep cable from the apex paddle and connect the hands-free therapy electrodes to the cable.

The Advisory function cannot be activated unless hands-free therapy electrodes are attached to the OneStep cable and used as the ECG monitoring lead.

The R Series can monitor the patient's ECG while pacing without the need for a separate ECG cable and ECG electrodes. This also allows demand pacing when separate ECG electrodes are either not connected, or unavailable. OneStep pacing capability requires the OneStep Pacing cable along with OneStep Pacing electrodes, or OneStep Complete electrodes.

Note: The ZOLL OneStep electrodes, MFE Pads, Pediatric MFE Pads, Stat-padz[®], and ECG electrodes are disposable, single-use items.

You should always check the expiration date on the electrode packaging. Do not use expired electrodes, which might result in false patient impedance readings and affect the level of delivered energy, or cause burns.



This symbol on the electrode package is accompanied by the expiration date.

The R Series defibrillator reads and reports the expiration date for all OneStep electrodes (except for OneStep Basic). When these electrodes exceed their expiration date, the Code Readiness indicator will change to a red “X.”

Note: ZOLL electrodes contain no hazardous materials and may be disposed of in general trash unless contaminated with pathogens. Use appropriate precautions when disposing of contaminated electrodes.

When the patient is less than 8 years old or weighs less than 55 lb. (25 kg), use ZOLL pediatric defibrillation electrodes. Do not delay therapy to determine the patient’s exact age or weight.

Batteries

R Series products use an easily replaced rechargeable lithium-ion battery pack (the ZOLL *SurePower* battery pack). A new, fully charged battery pack typically delivers more than 5 hours of ECG monitoring. Use of other functions (such as the defibrillator, printer, or pacemaker) reduces this time.

When a *LOW BATTERY* message appears on the display and the unit emits two beeps in conjunction with the displayed message, the battery must be replaced and recharged.

You can charge the battery by either of the following methods:

- **Internal charging** — plug the R Series into an AC power supply to automatically begin charging the installed battery pack. The front panel battery indicator operates as follows:

When the indicator is:	It means:
Steady yellow	Battery is charging
Steady green	Battery is charged
Alternating yellow and green	No battery is installed or a battery charging fault has been detected.
Not lit	The defibrillator is not connected to AC mains.

Note: Upon power up, it takes approximately 45 seconds for the LEDs on the battery to accurately display run time.

Note: The battery must be charged before first use.

- **External charging** — use the ZOLL *SurePower* Battery Charger to charge the battery pack and test the battery’s capacity. Battery status information can be viewed on a PC using ZOLL’s clinical review software products. For details, refer to the *ZOLL SurePower defibrillator battery Operator’s Manual*.

Code-Ready System

The R Series defibrillator's Code-Ready system tests the defibrillator whenever the unit is turned on, periodically during operation, whenever manual testing is initiated by the operator, and automatically, at pre-configured intervals.

The code readiness indicator on the front panel shows the result of the most recent readiness check. Also, OneStep Pacing, CPR or Complete electrodes provide an interface that communicates the electrode's expiration date and condition to the defibrillator.

The Defib Test Log stores the results for as many as 1000 defibrillator tests in internal memory. Each log entry shows the time and date of the defibrillator test. The Defib Test Log can be printed on the stripchart or transferred to a personal computer for printing and archiving.

Safety Considerations



All operators should review these safety considerations before using the R Series.

R Series products are high-energy defibrillators capable of delivering 200 joules. To completely deactivate the unit, turn the Mode Selector to **OFF**.

To manually disarm a charged (or charging) defibrillator, do one of the following:

- In AED mode, Turn the Mode Selector to **OFF**.
- In Manual mode, press the **Disarm** softkey.
- In Manual mode, turn the Mode Selector to **OFF** or **PACER**, or change the selected defibrillator energy.

For safety, in Manual mode, the R Series unit automatically disarms if left charged for more than either 60 or 120 seconds (user configurable) if the **SHOCK** button is not pressed; in AED mode, the R Series unit automatically disarms if left charged for more than 30 seconds.

Warnings

General

Federal (U.S.A.) law restricts this defibrillator to use by or on the order of a physician.

Only appropriately trained, skilled personnel who are familiar with equipment operation should perform emergency defibrillation. The prescribing physician should determine what training, such as Advanced Cardiac Life Support (ACLS) or Basic Life Support (BLS) certification, is appropriate.

Only skilled personnel trained in Advanced Cardiac Life Support (ACLS) and who are familiar with equipment operation should perform synchronized cardioversion. The precise cardiac arrhythmia must be determined before attempting defibrillation.

These operating instructions describe the functions and proper operation of the R Series products. They are not a substitute for a formal patient care training course. Operators should obtain formal training from an appropriate authority before using this defibrillator for patient care.

Proper operation of the unit and correct electrode placement is critical to obtaining optimal results. Operators must be thoroughly familiar with proper device operation.

The use of external pacing/defibrillation electrodes or adapter devices from sources other than ZOLL is not recommended. ZOLL makes no representations or warranties regarding the performance or effectiveness of its products when used with pacing/defibrillation electrodes or adapter devices from other sources. Defibrillator failures attributable to the use of pacing/defibrillation electrodes or adapters not manufactured by ZOLL might void ZOLL's warranty.

Do not disassemble the unit. A shock hazard exists. Refer all problems to authorized service personnel.

Follow all recommended maintenance instructions. If a problem occurs, obtain service immediately. Do not use the defibrillator until it has been inspected by appropriate personnel.

The R Series unit might not perform to specifications when stored at the upper or lower extreme limits of storage temperature and then immediately put into use.

Avoid using the R Series adjacent to, or stacked on, other equipment. If unavoidable, verify that the R Series operates normally in this configuration before clinical use.

The R Series should be installed and put into service according to the EMC information in Appendix A of this manual.

Assess the Wi-Fi performance for the possibility of RFI in your environment of use.

If multiple devices are transmitting simultaneously to the same access point, Wi-Fi data transfer will be slowed down. If the access point is too overloaded, data transmission failures can occur.

The use of accessories, transducers, and cables other than those specified in this manual and related R Series option manual inserts may result in increased emissions or decreased immunity of the R Series.

Do not use or place the unit in service if the Code Readiness indicator (at the upper right of the front panel) displays a red "X".

Carefully route patient cables to avoid tripping over them, or inadvertently pulling the unit onto the patient.

Always inspect the unit for damage if it has been dropped.

To avoid risk of electric shock, this equipment must only be connected to a supply mains with protective earth.

Do not modify this equipment without authorization from the manufacturer.

Ensure that the unit is always positioned so as to allow unobstructed access to and detachment of the power cord from the unit to AC mains.

ECG Analysis, Defibrillating, Pacing and CPR

Prior to attempting synchronized cardioversion, ensure the ECG signal quality is good and that sync markers are displayed above each QRS complex.

Do not use the unit in AED mode or advisory mode during patient movement. A patient must be motionless during ECG rhythm analysis. Do not touch the patient during analysis. If transporting the patient, cease all movement before beginning ECG analysis.

ECG rhythm analysis does not warn of patient asystole, which is not a shockable rhythm.

The ECG rhythm analysis function might not reliably identify ventricular fibrillation in the presence of an implanted pacemaker. Inspection of the electrocardiogram and clinical evidence of cardiopulmonary arrest should be the basis for any treatment of patients with an implanted pacemaker.

Implanted pacemakers might cause the heart rate meter to count the pacemaker rate during incidents of cardiac arrest or other arrhythmias. Dedicated pacemaker detection circuitry may not detect all implanted pacemaker spikes. Check the patient's pulse; do not rely solely on heart rate meters. Patient history and physical examination are important factors in determining the presence of an implanted pacemaker. Pacemaker patients should be carefully observed.

Do not place electrodes directly over an implanted pacemaker.

The R Series unit detects ECG electrical signals only. It does not detect a pulse (effective circulatory perfusion). Always verify pulse and heart rate by physical assessment of the patient. Never assume that the display of a nonzero heart rate means that the patient has a pulse.

To avoid possible damage to the R Series unit, turn off pacing before defibrillating the patient with a second defibrillator.

Do not use the unit's ECG-out signal as a synchronization pulse for another defibrillator or cardioverter.

Place the patient on a firm surface before performing CPR.

Battery

Do not operate the unit without a battery. Always have a source of available backup power for all anticipated use environments. A fully charged spare battery or ready access to AC mains power from a local wall outlet can provide this backup power.

Test battery packs regularly. A battery that does not pass the ZOLL charger's capacity test might cause the R Series unit to shut down unexpectedly.

When the warning *LOW BATTERY* appears, plug the R Series unit into a power source or install a fully charged battery pack. When the warning *REPLACE BATTERY* appears, immediately replace the battery pack with a fully charged pack or plug the R Series unit into a power source, as unit shut down due to a low battery condition is imminent.

If mistreated, a battery pack might explode. Do not disassemble a battery pack or dispose of it in fire.

Operator Safety



Do not use R Series products in the presence of oxygen-rich atmospheres, flammable anesthetics, or other flammable agents (such as gasoline). Using the unit in such environments might cause an explosion.

Do not use the unit near or within standing water. Electrical safety might be compromised when the defibrillator is wet.

Never discharge the unit with the defibrillation electrodes or paddles shorted together or in open air.

Do not discharge the defibrillator except as indicated in the instructions. Discharge the defibrillator only when defibrillation electrodes or paddles are properly applied to the patient.

To avoid risk of electrical shock, do not touch the gelled area of the hands-free therapy electrodes during pacing or defibrillation.

To avoid risk of electrical shock, do not allow electrolyte gel to accumulate on hands or paddle handles.

To avoid risk of electrical shock, do not allow patient connectors to contact other conductive parts, including earth.

For defibrillation using paddles, use only high-conductivity electrolyte gel specified for such use by the manufacturer.

When using paddles for defibrillation, use your thumbs to operate the **SHOCK** buttons. Doing so avoids inadvertent shock to the operator and unintentional depression of an **ENERGY SELECT** button, which causes the defibrillator to disarm. Keep your hands and fingers away from the paddle plates.

The use of accessory equipment that does not comply with the equivalent safety requirements of the R Series defibrillator could reduce the level of safety of the combined system. When choosing accessory equipment, consider the following:

- Use of the accessory in the patient vicinity.
- Evidence that the safety certification of the accessory has been performed in accordance with the appropriate IEC (EN) 60601-1 and/or IEC (EN) 60601-1-1 harmonized national standards.

Always check that the equipment functions properly and is in proper condition before use.

Disconnect all electro-medical equipment that is not defibrillation-protected from the patient prior to defibrillation.

Before discharging the defibrillator, warn everyone to **STAND CLEAR** of the patient.

Do not touch the bed, patient, or any equipment connected to the patient during defibrillation. A severe shock can result. To avoid hazardous pathways for the defibrillation current, do not allow exposed portions of the patient's body to touch any metal objects, such as a bed frame.

When the R Series is performing a Code Readiness test, as indicated on the display, do not touch the connected paddles, electrodes, or OneStep cable connector.

Patient Safety



This equipment should be connected to only one patient at a time.

Use only OneStep Pediatric electrodes to defibrillate patients under 8 years of age in AED or advisory modes. Use of adult electrodes, or pediatric electrodes other than OneStep Pediatric electrodes, can result in the delivery of excessive energy doses.

Neonatal and pediatric defibrillation energy level settings should be based on site-specific clinical protocols.

To ensure patient safety, connect the R Series only to equipment with galvanically isolated circuits.

Use only high-quality ECG electrodes. ECG electrodes are for rhythm acquisition only; you cannot use ECG electrodes for defibrillation or pacing.

Do not use therapy or ECG electrodes if the gel is dried, separated, torn or split from the foil; patient burns may result from using such electrodes. Poor adherence and/or air pockets under therapy electrodes can cause arcing and skin burns.

Check the expiration date on the electrode packaging. Do not use electrodes after their expiration date.

Excessive body hair or wet, diaphoretic skin can inhibit electrode coupling to the skin. Clip excess hair and dry any moisture from the area where an electrode is to be attached.

Therapy electrodes should be replaced periodically during continuous pacing. Consult electrode directions for proper replacement instructions.

Prolonged pacing (more than 30 minutes), particularly in neonates or adults with severely restricted blood flow, may cause burns. Periodically inspect the skin under the electrodes.

Carefully route the patient cables to reduce the possibility of patient entanglement or strangulation.

To avoid electrosurgery burns at monitoring sites, ensure proper connection of the electrosurgery return circuit so that a return path cannot be made through monitoring electrodes or probes.

During electrosurgery, observe the following guidelines to minimize electrosurgery unit (ESU) interference and provide maximum operator and patient safety:

- Keep all patient monitoring cables away from earth ground, ESU knives, and ESU return wires.
- Use electrosurgical grounding pads with the largest practical contact area.

Always ensure proper application of the electrosurgical return electrode to the patient.

Check electrical leakage levels before use. Leakage current might be excessive if more than one monitor or other piece of equipment is connected to the patient.

Do not use the ZOLL OneStep Pacing cable (**REF** 1009-0913-01) or the ZOLL Multi-Function Cable (**REF** 1009-0913-03) in a 220/240 VAC 60Hz power environment. Patient leakage current may be excessive.

Do not place the unit in contact with a patient. Burns may result.

Cautions

If the unit is to be stored longer than 90 days, remove the battery pack.

Do not sterilize the defibrillator, or its accessories unless the accessories are labelled as sterilizable.

Do not immerse any part of the defibrillator in water.

Do not use ketones (such as acetone or MEK) on the defibrillator.

Avoid using abrasives (including paper towels) on the display window.

To protect the unit from damage during defibrillation, for accurate ECG information, and to protect against noise and other interference, use only internal current-limiting ECG cables specified or supplied by ZOLL.

For continued safety and EMI performance, use only the line cord supplied by ZOLL.

Dispose of battery packs in accordance with national, regional and local regulations. Battery packs should be shipped to a reclamation facility for recovery of metal and plastic compounds as the proper method of waste management.

Restarting the Defibrillator

Certain events require the R Series products to be restarted after they shut off or become inoperative (for example, when the battery runs down and the unit shuts off).

In such a case, always try to restore defibrillator operation as follows:

1. Turn the Mode Selector to **OFF**.
2. If necessary, replace a depleted battery with a fully charged pack, or connect the defibrillator to AC mains.
3. Turn the Mode Selector to the desired operating mode to restart the unit.

This sequence is necessary to restart the defibrillator and can also be used to clear some fault messages when immediate use of the defibrillator is required.

If restarted after a shutdown period of 10 seconds or more, the unit restores all settings (such as ECG lead, ECG size, and alarm state and limits) to their power-up default values. After restoring device operation, you might need to reinstate previously selected, non-default settings.

FDA Tracking Requirements

U.S. Federal Law (21 CFR 821) requires the tracking of defibrillators. Under this law, owners of this defibrillator must notify ZOLL Medical Corporation if this product is

- received
- lost, stolen, or destroyed
- donated, resold, or otherwise distributed to a different organization

If any such event occurs, contact ZOLL Medical Corporation in writing with the following information:

1. Originator's organization – Company name, address, contact name, and contact phone number
2. Model number, and serial number of the defibrillator
3. Disposition of the defibrillator (for example, received, lost, stolen, destroyed, distributed to another organization), new location and/or organization (if known and different from originator's organization) – company name, address, contact name, and contact phone number
4. Date when the change took effect

Please address the information to:

ZOLL Medical Corporation
Attn: Tracking Coordinator
269 Mill Road
Chelmsford, MA 01824-4105

Fax: (978) 421-0025
Telephone: (978) 421-9655

Notification of Adverse Events

As a health care provider, you may have responsibilities under the Safe Medical Devices Act (SMDA), for reporting to ZOLL Medical Corporation, and possibly to the FDA, the occurrence of certain events.

These events, described in 21 CFR Part 803, include device-related death and serious injury or illness. In addition, as part of our Quality Assurance Program, ZOLL Medical Corporation requests to be notified of device failures or malfunctions. This information is required to ensure that ZOLL Medical Corporation provides only the highest quality products.

EU Notification

The Summary of Safety and Clinical Performance (SSCP) is available in the European database on medical devices (Eudamed) – <https://ec.europa.eu/tools/eudamed>.

The Basic UDI-DI is 8479460WTR.

Any serious incident that has occurred in relation to the device should be reported to the manufacturer and the competent authority of the Member State in which the user and/or patient is established.

Software License

Note: Read this Operator's Guide and License agreement carefully before operating any of the R Series products.

Software incorporated into the system is protected by copyright laws and international copyright treaties as well as other intellectual property laws and treaties. This software is licensed, not sold. By taking delivery of and using this system, the Purchaser signifies agreement to and acceptance of the following terms and conditions:

1. **Grant of License:** In consideration of payment of the software license fee which is part of the price paid for this product ZOLL Medical Corporation grants the Purchaser a non-exclusive license, without right to sublicense, to use the system software in object-code form only.
2. **Ownership of Software/Firmware:** Title to, ownership of and all rights and interests in the system software and all copies thereof remain at all times vested in the manufacturer, and Licensors to ZOLL Medical Corporation and they do not pass to purchaser.
3. **Assignment:** Purchaser agrees not to assign, sublicense or otherwise transfer or share its rights under the license without the express written permission of ZOLL Medical Corporation.
4. **Use Restrictions:** As the Purchaser, you may physically transfer the products from one location to another provided that the software/firmware is not copied. You may not disclose, publish, translate, release or distribute copies of the software/firmware to others. You may not modify, adapt, translate, reverse engineer, decompile, crosscompile, disassemble or create derivative works based on the software/firmware.

NO IMPLIED LICENSE

Possession or purchase of this device does not convey any express or implied license to use the device with replacement parts which would, alone, or in combination with this device, fall within the scope of one or more of the patents relating to this device.

Service

The R Series does not require periodic recalibration or adjustment. Appropriately trained and qualified personnel should, however, perform periodic tests of the defibrillator to verify proper operation.

If a unit requires service, contact the ZOLL Technical Service Department.

For customers In the U.S.A.	For customers outside the U.S.A.
Telephone: 1-800-348-9011 1-978-421-9655 Fax: 1-978-421-0010	Call the nearest authorized ZOLL Medical Corporation representative. To locate an authorized service center, contact the International Sales Department at ZOLL Medical Corporation 269 Mill Road Chelmsford, MA 01824-4105 Telephone: 1-978-421-9655

When requesting service, please provide the following information to the service representative:

- Unit serial number
- Description of the problem
- Department using the equipment and name of the person to contact
- Purchase order to allow tracking of loan equipment
- Purchase order for a unit with an expired warranty
- Sample ECG or other stripcharts demonstrating the problem (if available and applicable), less any confidential patient information.

Returning a unit for service

Before sending a unit to the ZOLL Technical Service Department for repair, obtain a service request (SR) number from the service representative.

Remove the battery pack from the unit. Pack the unit with its cables and battery in the original containers (if available) or equivalent packaging. Be sure the assigned service request number appears on each package.

For customers	Return the unit to
In the U.S.A.	ZOLL Medical Corporation 269 Mill Road Chelmsford, MA 01824-4105 Attention: Technical Service Department (<i>SR number</i>) Telephone: 1-800-348-9011

For customers	Return the unit to
In Canada	ZOLL Medical Canada Inc. 1750 Sismet Road, Unit #1 Mississauga, ON L4W 1R6 Attention: Technical Service Department (<i>SR number</i>) Telephone: 1-866-442-1011
In other locations	The nearest authorized ZOLL Medical Corporation representative. To locate an authorized service center, contact the International Sales Department at ZOLL Medical Corporation 269 Mill Road Chelmsford, MA 01824-4105 Telephone: 1-978-421-9655

The ZOLL Serial Number

Each ZOLL product displays a serial number that contains information about that product. From left to right, ZOLL serial numbers are structured as follows:

- A two-character product code
- A three-character date-of-manufacture code
- A product serial number of six or more alphanumeric characters

The product code for the R Series defibrillator is AF.

The first two characters of the date-of-manufacture code give the last two digits of the year (for example, “06” appears for products manufactured in 2006). The last character of the date-of-manufacture code gives the month in which the product was manufactured. The month appears in the form of a single alphanumeric character: “A” for January, “B” for February, “C” for March, and so on through “L” for December.

The product serial number is a unique set of alphanumeric characters that ZOLL assigns to each individual unit.

Chapter 2

Product Overview

Defibrillator Controls and Indicators

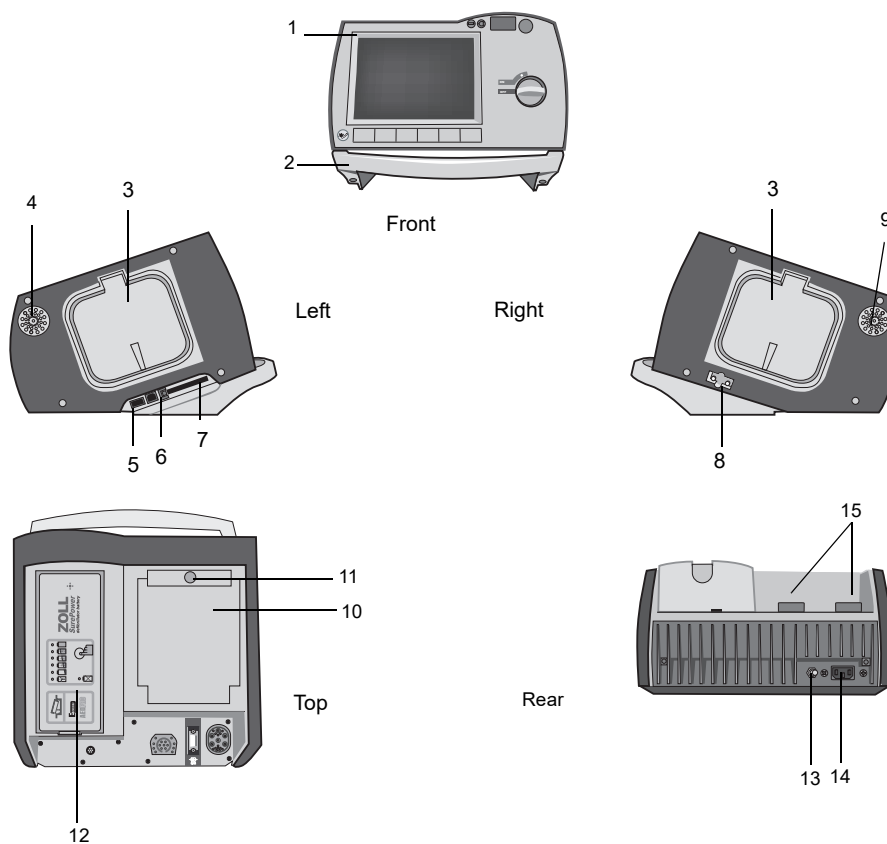

Table 2-1. R Series Unit Features

	Item	Description
1	Front panel	Includes the display screen and primary controls.
2	Handle	Integrated carrying handle.
3	External paddle well	Holds paddles when not in use. Allows defib self-test when paddles are stowed in their respective wells.
4	Beeper	Emits R-wave detection beeps, defib charge Ready tones, and alarm tones.
5	USB host connector (Optional)	(Reserved for future use — do not connect to any equipment.)
6	USB device connector	For connecting the R Series defibrillator to a USB device. For details, refer to “Event Records and Reports” on page 11-1.
7	Data card slot	Holds a compact flash card for copying data stored in the device’s internal memory. Accepts a CF memory card or a Wi-Fi card.
8	Defibrillator test port	When not using OneStep electrodes or paddles, connect the patient end of a OneStep cable to this port to allow device checks.
9	Speaker	Issues voice prompts.
10	Paper Compartment	Holds the paper for the stripchart printer.
11	RELEASE button	Allows access to the paper compartment.
12	Battery compartment	Holds a rechargeable lithium ion battery pack.
13	Grounding post	Earth-grounded terminal provided for the convenient connection of biomedical test equipment requiring an equipotential ground. This terminal has no clinical function and should not be used for electrical safety purposes.
14	AC mains connector	For connecting the device to an AC power source.
15	Patient connectors	For details, refer to “Patient Cables and Connectors” on page 2-8.

The Front Panel

The front panel of the R Series device includes the display screen, softkeys, battery indicator, AC power indicator, Code Readiness indicator, **SHOCK** button, and control panel. The control panel configuration varies slightly depending on the model and whether the unit is in AED mode or Manual mode. See Figure 2-1 and Figure 2-2.

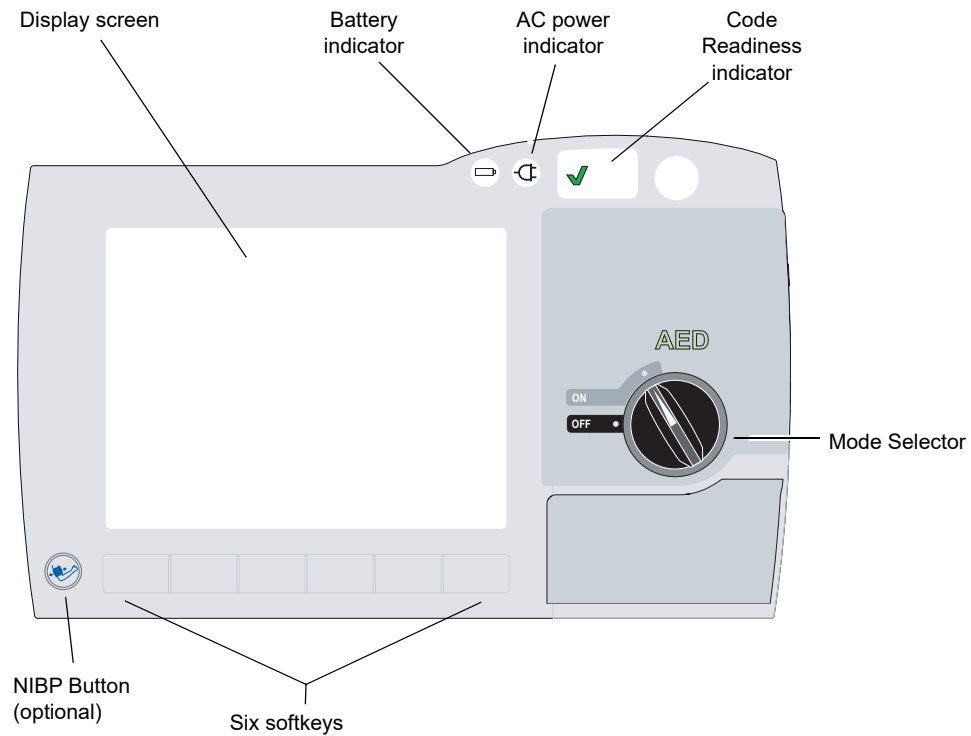

Figure 2-1. R Series Front Panel (AED Mode)

Table 2-2 describes the controls and indicators that appear on the front panel.

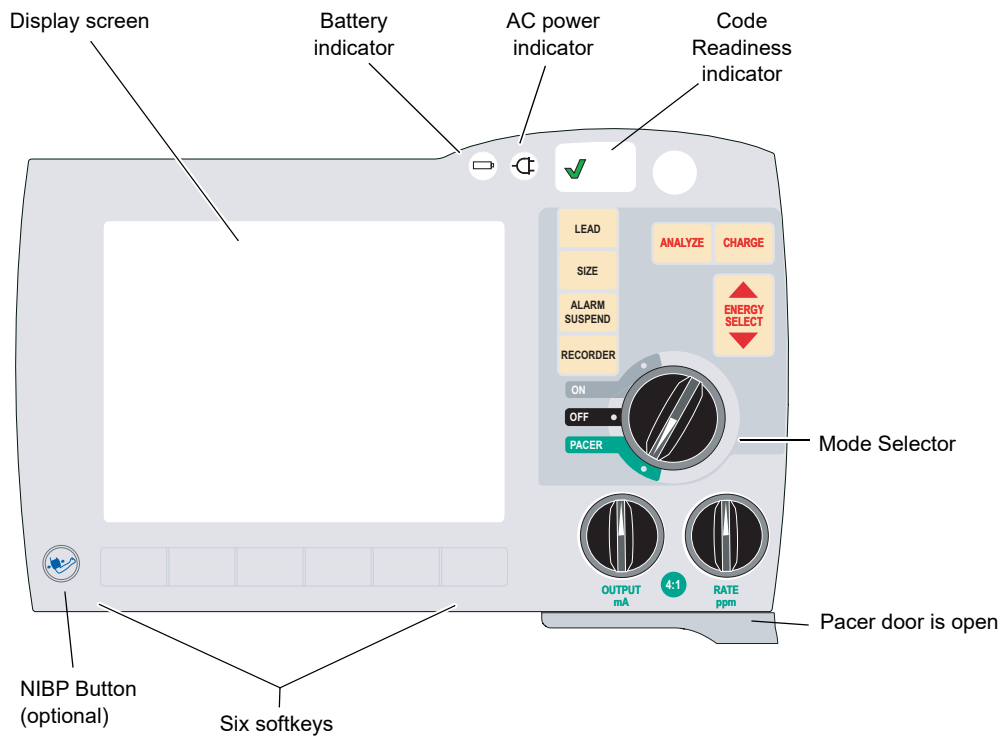

Figure 2-2. R Series Front Panel (Manual Mode)

Table 2-2. R Series Controls and Indicators

Control or Indicator	Description
Display screen	Shows therapeutic settings, physiological waveforms, and other information for each monitored parameter, messages, time, and softkey labels.
Battery indicator	Indicates battery status: Steady yellow: Battery is charging. Steady green: Battery is charged. Alternating yellow and green: No battery is installed, or there is a battery charging fault.
Indicator for AC power	Illuminated when the unit is plugged into an alternating current (AC) power source.
Code Readiness indicator	Shows the status of the unit, based on its most recent Readiness check: <ul style="list-style-type: none"> • A green “✓” indicates the unit is ready for therapeutic use. • A red “X” indicates the unit’s Readiness is compromised and that it may not be ready for therapeutic use.
Mode Selector	Selects the mode of operation (available options depend on model): <ul style="list-style-type: none"> • OFF — Unit is powered off. • ON — Unit is automatically powered on in AED mode. • PACER — Unit is in pacer mode (pacer door drops open).
ENERGY SELECT Buttons	Display in Manual mode only. Two sets of up-down arrow buttons control the selection of defibrillator energy, one set located on the front panel and the other located on the sternum paddle.

Table 2-2. R Series Controls and Indicators (continued)



Control or Indicator	Description
CHARGE Button	Displays in Manual mode only. Charges the defibrillator to the selected energy. In addition to the CHARGE button on the front panel, there is one located on the apex paddle handle.
SHOCK Button	The front panel SHOCK button is only active when using OneStep electrodes, hands-free therapy electrodes (see "R Series Accessories" on page B-1 for a list), external autoclavable paddles, or internal defibrillation paddles without a discharge button. The SHOCK button illuminates when the device is charged and ready. To discharge the defibrillator when using paddles (internal or external) with discharge buttons, press and hold the SHOCK buttons on the paddles.
ANALYZE Button	Displays in Manual mode only. Initiates ECG analysis to determine whether or not a shockable rhythm is present.
LEAD Button	Displays in Manual mode only. Selects the ECG source for display and printing. Pressing this button sequentially selects ECG signals derived from each of the following lead configurations: I, II, III, aVR, aVL, aVF, PADDLES, or PADS, P1, P2, and P3 (when using OneStep Pacing electrodes, or OneStep Complete electrodes with OneStep Pacing cable) for display. The PADS or PADDLES lead setting is automatically selected when the defibrillator is turned to Manual mode with either hands-free therapy electrodes or paddles attached to the OneStep cable. Lead II or P3 (OneStep Pacing) is automatically selected when the R Series is powered up in PACER mode. Pads or Paddles monitoring is not available in PACER mode.
SIZE Button	Displays in Manual mode only. Selects the relative amplitude scale factor for the displayed ECG waveform. Available scale factors are x0.5, x1, x1.5, x2 and x3
ALARM SUSPEND Button	Displays in Manual mode only. Activates, deactivates or audibly suspends all alarm functions. A bell symbol () appears on the display when alarms are enabled. When alarms are either audibly or permanently disabled, an "X" appears across the bell () symbol.
RECORDER Button	Displays in Manual mode only. Starts or stops the stripchart recorder. When the ECG lead is selected, you can switch the unit to diagnostic ECG bandwidth (0.05 - 150Hz) by pressing and holding the RECORDER button. Diagnostic bandwidth is maintained as long as the RECORDER button is held down. When the RECORDER button is released, the unit reverts to standard monitoring bandwidth.
PACER OUTPUT mA (optional)	When pacing is selected, this control sets the amount of current delivered. The selected current setting is indicated on the display.
PACER RATE ppm (optional)	When pacing is selected, this control sets the rate (pulses per minute) at which the pacemaker will operate. The selected pace rate setting is indicated on the display.
4:1 Button (optional)	This button is used to determine a patient's underlying ECG rhythm. While depressed, this button causes pacing stimuli to be delivered at $\frac{1}{4}$ of the indicated ppm setting. When the button is released, normal pacing resumes.

Table 2-2. R Series Controls and Indicators (continued)

Control or Indicator	Description
NIBP Button (optional)	Allows you to start single, auto, or STAT non-invasive blood pressure measurements as described in the option insert <i>Non-Invasive Blood Pressure</i> (part number 9650-0914-01). Your unit has this button only if you ordered this configuration.
Softkeys	Six unlabeled buttons located directly below the display control different functions depending on the operating mode of the unit. Labels for the softkeys appear at the bottom of the display directly above each softkey to indicate its function.
Charge Indicator Light (not shown)	Located on the apex paddle, this light turns on when the defibrillator is charged and ready.

Display Screen

Note: The screen content depends on the operational mode and the options installed.

The front panel includes a color display which shows:

- The elapsed time (since the unit was turned on).
- The ECG trace, selected lead, size, heartbeat indicator, and alarm status.
- The selected energy, charging status, and delivered energy for defibrillation and synchronized cardioversion.
- The output current and stimulus rate for pacing.
- The measured SpO₂ percent saturation, signal strength, plethysmographic trace (if applicable), and alarm status indicators for SpO₂ monitoring (optional).
- Non-invasive blood pressure (NIBP) readings: diastolic, systolic, and mean, plus alarm status indicators (optional; refer to the option insert *Non-Invasive Blood Pressure (NIBP)*, part number 9650-0914-01).
- The patient's carbon dioxide level, respiration rate and capnogram (if applicable), and alarm status indicators for CO₂ monitoring (optional; refer to the option insert *End Tidal Carbon Dioxide (EtCO₂)*, part number 9650-0915-01).
- Messages and prompts.
- Labels above the softkeys (appropriate to the context).
- Perfusion Performance Indicator and Release Bar (R Series Plus Only).
- CPR Rate and Depth.
- Remaining CPR Timer.

Figure 2-3 shows the layout of parameter values, waveforms, system data, and softkey labels.

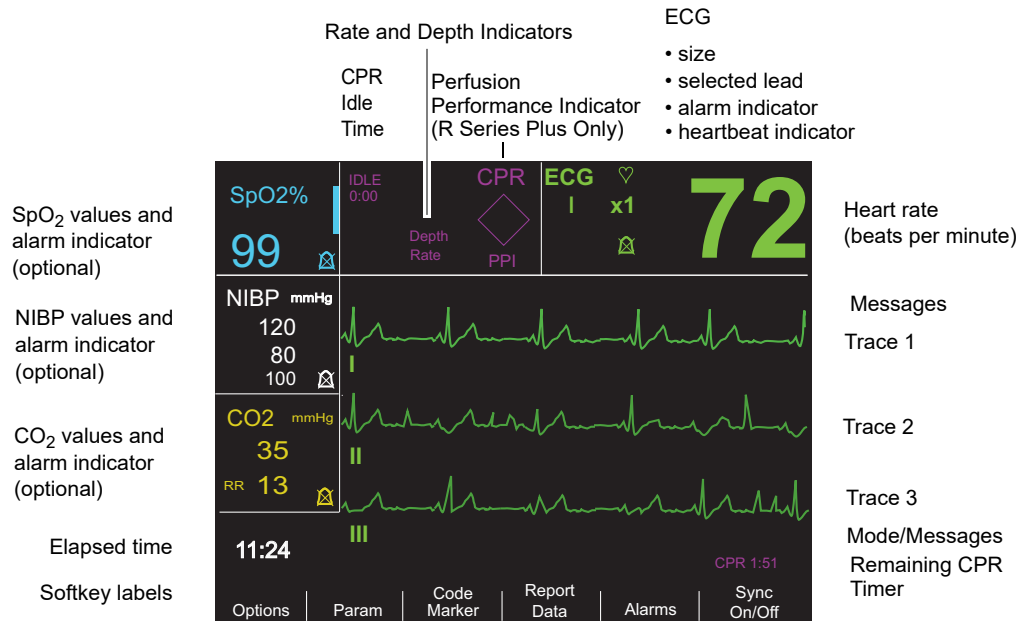

Figure 2-3. R Series Display Screen (shown in manual mode with optional SpO₂, NIBP and CO₂ monitoring)

Color coding

To differentiate information for various parameters, the unit displays each type of information in a specific user-configurable color.

Messages

During operation, a fault or error message is displayed when a fault is detected. If this occurs, turn the unit off and then on and recheck operation. If the fault persists, contact your authorized ZOLL agent as described on page 1-23.

Patient Cables and Connectors

The back of the unit includes a set of connectors for patient cables.

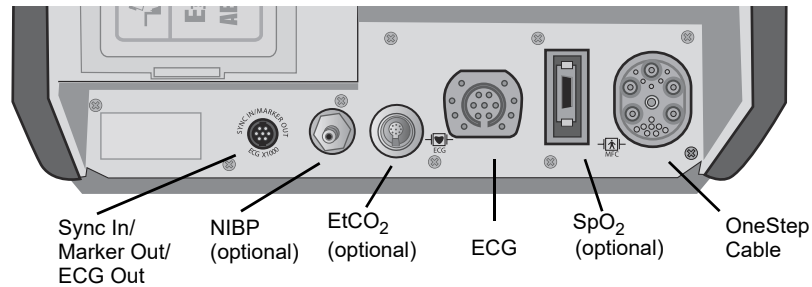

Figure 2-4. Patient Cable Connectors

Connector	Description
OneStep Cable	For connecting paddles or ZOLL hands-free therapy and pacing electrodes using either OneStep or OneStep Pacing cables.
ECG	For connecting 3- or 5-lead ECG cable or OneStep Pacing cable's ECG cable.
Sync In / Marker Out / ECG x1000	Connector for <ul style="list-style-type: none"> An incoming defibrillator synchronization signal from an external patient monitor. Output of R wave marker to an external patient monitor. ECG signal output for use with other equipment such as patient monitors and radio telemetry equipment (1 V/cm of displayed ECG signal).
NIBP	(Optional) For connecting blood pressure cuff cable.
EtCO ₂	(Optional) For connecting CO ₂ monitor cable.
SpO ₂	(Optional) For connecting pulse oximeter cable.

OneStep Cables

The R Series ships with either a OneStep cable, a OneStep Pacing cable or an MFC with CPR-D connector cable.

The OneStep Pacing cable has an additional connector that plugs into the rear panel ECG connector. This cable is used with OneStep Pacing electrodes or OneStep Complete electrodes for external pacing and ECG monitoring. Alternatively, you can disconnect the OneStep Pacing cable from the ECG connector and use a 3- or 5-lead ECG cable.

The MFC with CPR-D connector is used with CPR-D-padz[®] and Real CPR Help.

Note: The MFC with CPR-D connector cable does not support usage with external or internal paddles.

Note: Use only cables that are intended for the R Series unit. If a cable for another ZOLL product is plugged in, the message *INVALID ADAPTER* may appear.

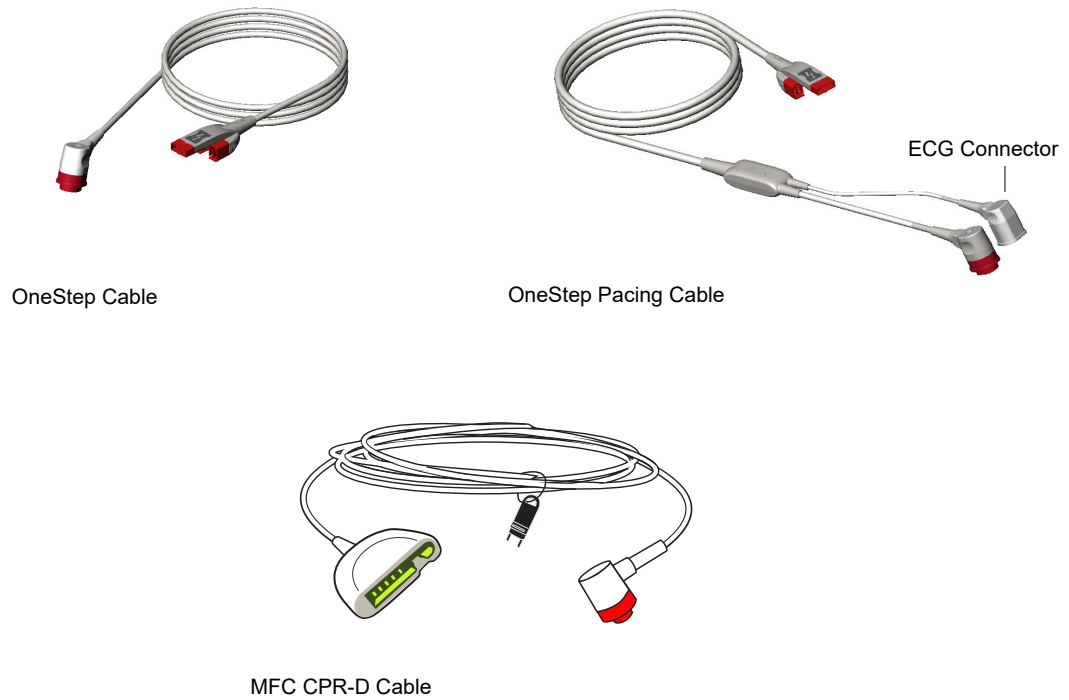

Figure 2-5. OneStep Cables

OneStep Cable Manager (Optional)

As an option, the OneStep Cable Manager is available to store and organize cables.

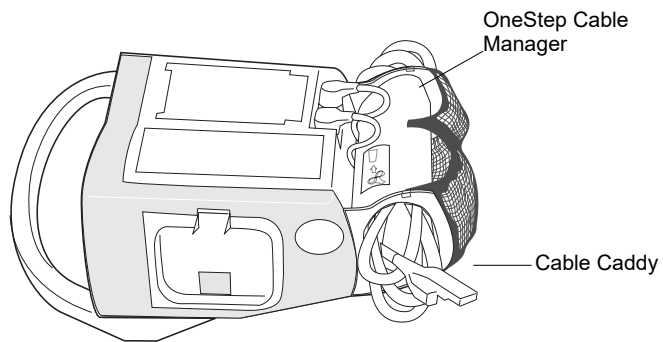
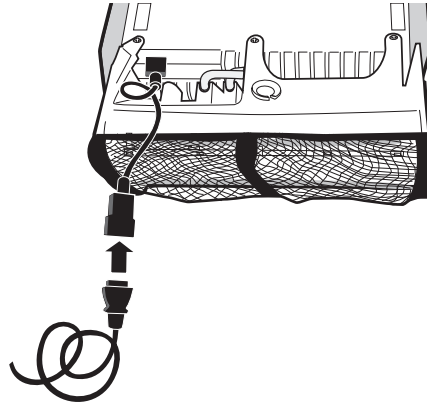

Figure 2-6. The R Series with the Optional OneStep Cable Manager (Side View)

Power Cord

The AC power cord is used to operate the R Series unit when battery power is not being used. An additional extension cord is available for use when the cable organizer accessory is attached to the unit. The extension cord plugs into the main AC power cord as shown below.



External Paddles (Manual Mode Only)



Paddles are defibrillation-proof Type BF equipment.

The external paddles on the R Series device are used for defibrillation and synchronized cardioversion.

Caution You cannot use paddles for ECG analysis or pacing.

Defibrillation paddles can be used for ECG monitoring when it is not practical to apply ECG electrodes. Press the **LEAD** button to select PADDLES as the ECG source.

The paddles are stowed in wells on either side of the unit. To release the paddles, grasp the handles and then press down on the latch button above each paddle.

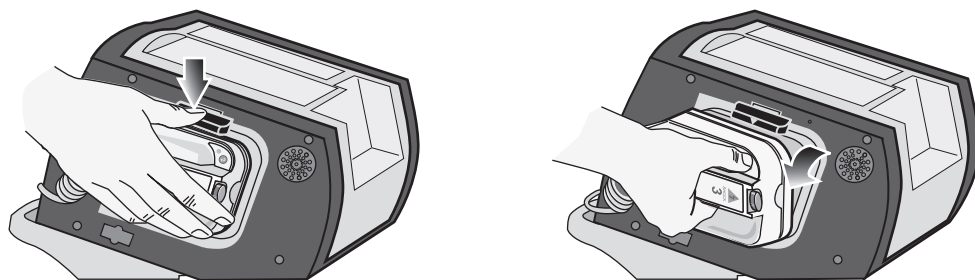

Figure 2-7. Releasing the Paddles

Attach the OneStep cable from the R Series unit to the connector at the base of the apex paddle.

1. Align OneStep cable as shown.

2. Insert OneStep cable into APEX paddle.



Figure 2-8. Attaching the OneStep Cable to the APEX Paddle

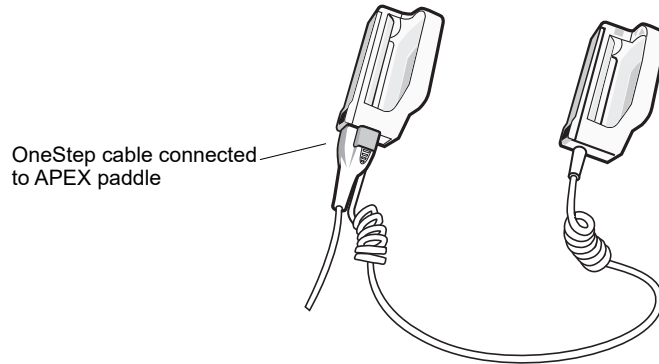

Figure 2-9. OneStep Cable Connected to APEX Paddle

If you need to detach the OneStep cable from the APEX paddles, push the **RELEASE** button (see Figure 2-10) in the direction of the arrow and unplug the OneStep cable.

Refer to Chapter 4, "Manual Defibrillation" before using paddles for defibrillation. The paddles include controls for selecting defibrillation energy, charging, delivering a shock, and turning the stripchart recorder on and off.

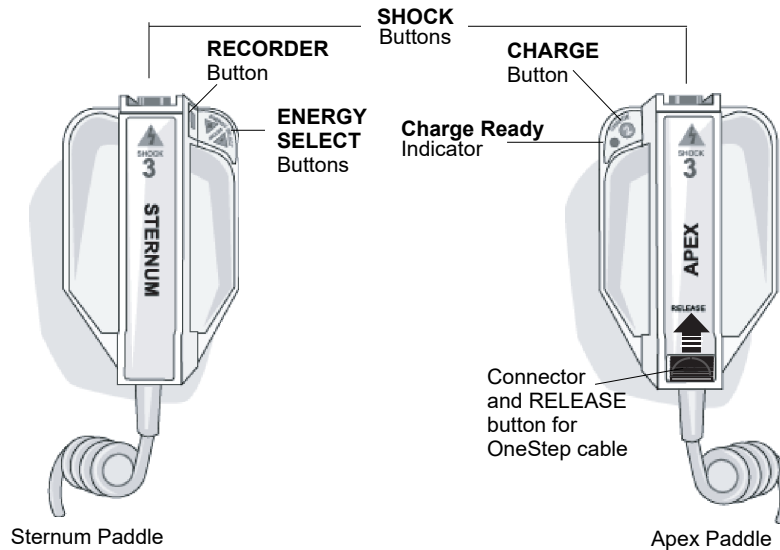
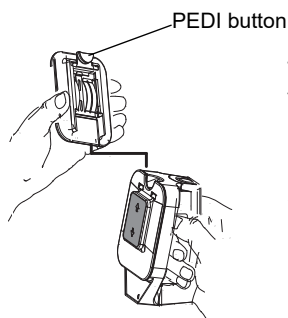

Figure 2-10. External Paddles

Pediatric-size electrodes are built into the paddle assembly beneath the standard electrode plates. The user must manually adjust energy settings to pediatric levels consistent with their institution’s protocols.



To expose the pediatric plate, press the PEDI button at the top of the paddle, then slide the Adult plate upward. Before replacing the Adult plate, be sure to clean the pediatric plate and surrounding area thoroughly. Slide the Adult plate onto the paddle until it locks into place.

Figure 2-11. Pediatric Plate

Note: The R Series defibrillator also supports ZOLL autoclavable internal handles for use during open chest defibrillation procedures.

Working with Menus (Manual Mode Only)

For some functions, the screen shows a menu of options with related softkeys for navigating through the menus and making selections and entries.

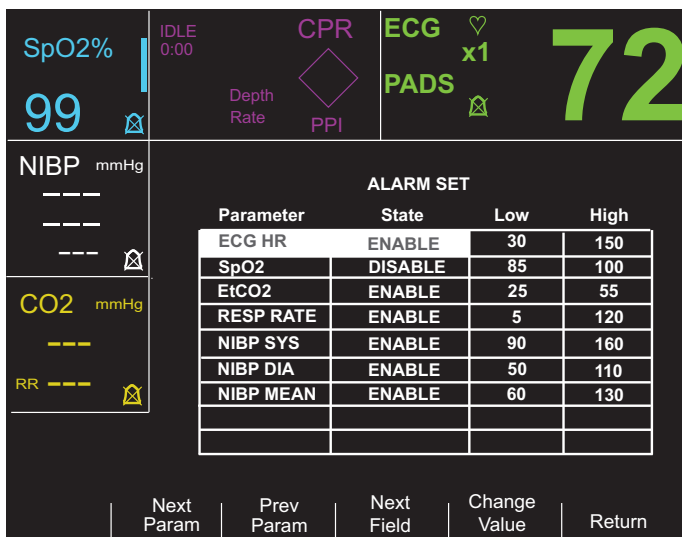

Figure 2-12. Example Display Screen

On the display, highlighting indicates the currently selected item, that is, the item or value you are working with.

The following table summarizes some of the more common softkeys.

Softkey	Action
Next Item	Moves the highlighting down to the next item in a vertical list.
Next Field	Moves the highlighting down to the next item in a horizontal list.
Prev Item	Moves the highlighting up to the previous item in a vertical list.
Next Digit	Moves the highlighting to the right in a series of letters or digits.
Prev Digit	Moves the highlighting to the left in a series of letters or digits.
Inc Inc Digit	Increases the highlighted value or digit. (For example, changes 2 to 3 or B to C).
Dec Dec Digit	Decreases the highlighted value or digit. (For example, changes 2 to 1 or B to A).
Newer	Moves the highlighting to the adjacent item with the more recent date or time.
Older	Moves the highlighting to the adjacent item with the older date or time.
Enter	Accepts the settings with the values currently shown.
Return	Displays the previous menu.
Next Param	Moves the highlighting to the next parameter.
Prev Param	Moves the highlighting to the previous parameter.
Change Value	Changes the value of the selected parameter.

Common Tasks

Follow the instructions in the subsequent sections for:

- “Replacing a Battery Pack” on page 2-13.
- “Adjusting Display Brightness (Manual Mode Only)” on page 2-14.
- “Using Code Markers (Manual Mode Only)” on page 2-14.

Replacing a Battery Pack

To remove a battery pack, press the tab on the end of the battery pack inward, and lift the battery pack out of the compartment.

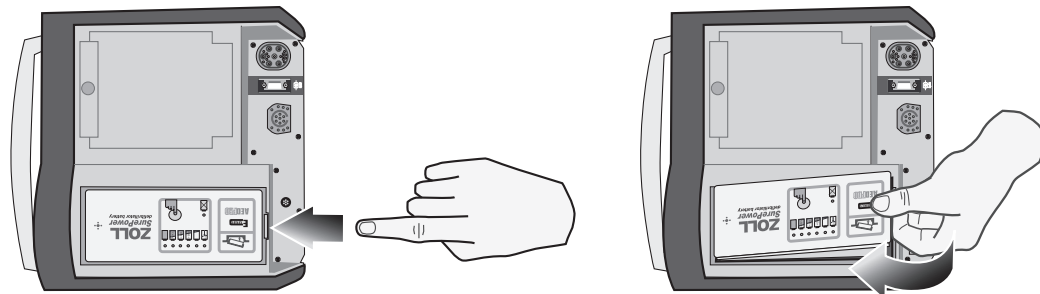

Figure 2-13. Removing a Battery Pack

To install a battery pack:

1. Place the end of the battery pack opposite the tab into the end of the compartment closest to the front of the unit.
2. Lower the tabbed end of the battery pack into the compartment and press down on the tabbed end until it locks into place.

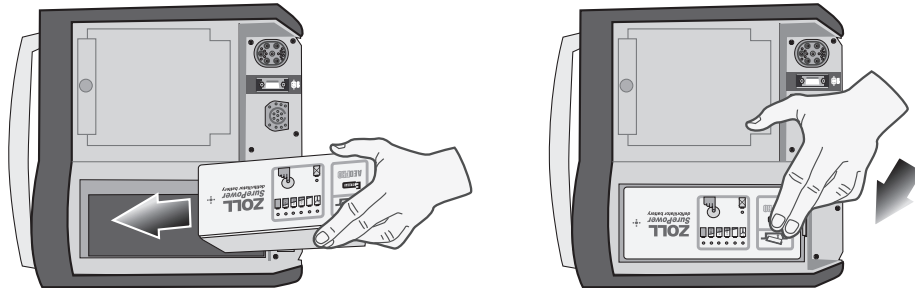

Figure 2-14. Installing a Battery Pack

Adjusting Display Brightness (Manual Mode Only)

To adjust brightness:

1. Turn the Mode Selector to **ON**.
 2. Press the **Manual Mode** softkey.
- Note:** If the *CONFIRM MANUAL MODE* message displays, press the **Confirm** softkey to enter the Manual mode of operation.
3. Press the **Options** softkey.
 4. Press the **High Bright** or **Low Bright** softkey to select high and low brightness.

Note: Brightness level affects battery run time. Selecting high bright will cause the battery charge to be depleted at a faster rate than when selecting low bright.

Using Code Markers (Manual Mode Only)

Pressing the **CODE MARKER** softkey causes the unit to display a preconfigured list of clinical actions. Pressing the softkey associated with a particular action causes that action, and 6 seconds of ECG, to be recorded along with a date and time stamp in the Summary Report memory. You can supplement an event summary by manually adding code markers which itemize drugs or treatments administered to the patient.

Up to six Code Markers can be displayed on the screen at one time.



Figure 2-15. Code Markers

The right-most softkey is labeled MORE when there are more than six items on the code marker list. Press the MORE softkey to see the next set of Code Markers displayed above the softkeys.

Separate code marker lists are maintained for DEFIB and PACER modes, thereby enabling the display of appropriate code markers for each particular protocol. (For information on configuring these code marker lists, refer to the *R Series Configuration Guide*.)

The code markers are removed from the display after 10 seconds. If no Code Marker softkey has been pressed during that time, a “default” event mark is stored in Summary Report memory.

(This page intentionally left blank.)

Chapter 3

Automated External Defibrillator (AED) Operation



ZOLL hands-free therapy electrodes are a defibrillation-protected Type BF patient connection.

WARNING! Use only One-Step Pediatric electrodes to defibrillate patients under 8 years of age in AED mode. Use of adult electrodes with pediatric patients can result in the delivery of excessive energy doses.

This chapter describes the recommended method of operation in AED Mode. The R Series unit is configured to operate in compliance with the American Heart Association and European Resuscitation Council Guidelines for Adult Basic Life Support and Use of Automated External Defibrillators.^{1,2} If your local protocol requires a different procedure, follow that protocol. (See the *R Series Configuration Guide* for instructions on how to configure the R Series to operate with other treatment protocols.)

This chapter also describes how to switch the AED unit to Manual mode (see “Switching to Manual Mode Operation” on page 3-10).

-
1. *Circulation*, 2005; 112; IU-19 — IU-34
 2. *Resuscitation* (2005); 671S, S7-S23

The R Series defibrillator is capable of analyzing a patient's ECG rhythm in two different ways. The first mode of analyzing is automatic; the other mode of analyzing is user activated analysis and is initiated by pressing the **ANALYZE** softkey.

Automatic and user activated analysis of a patient's ECG can be performed only when:

- Hands-free therapy electrodes are connected, and making good contact with the patient.
- Mode Selector is turned to ON.

This analysis normally consists of three consecutive 3-second ECG rhythm analyses. If at least two of the three analyses determine that the patient has a shockable rhythm, the unit automatically charges to the preconfigured energy level and prompts the operator to shock the patient. If two or more of the three 3-second ECG analyses do not detect a shockable rhythm, the unit alerts the operator that no shock is advised.

If the shock button is pressed and a shock is successfully delivered, the shock count increments by one and is displayed on the screen.

AED Operation

Determine Patient Condition Following Medical Protocols

Verify:

- Unconsciousness.
- Absence of breathing.
- Absence of pulse.

Begin CPR Following Medical Protocols

Request additional assistance.

Prepare Patient

Remove all clothing covering the patient's chest. Dry chest if necessary. If the patient has excessive chest hair, clip or shave it to ensure proper adhesion of the electrodes.

Attach hands-free therapy electrodes according to instructions on the electrode packaging.

Ensure that the electrodes are making good contact with the patient's skin and are not covering any part of the ECG electrodes.

Connect the hands-free therapy electrodes to the OneStep cable if not already connected.

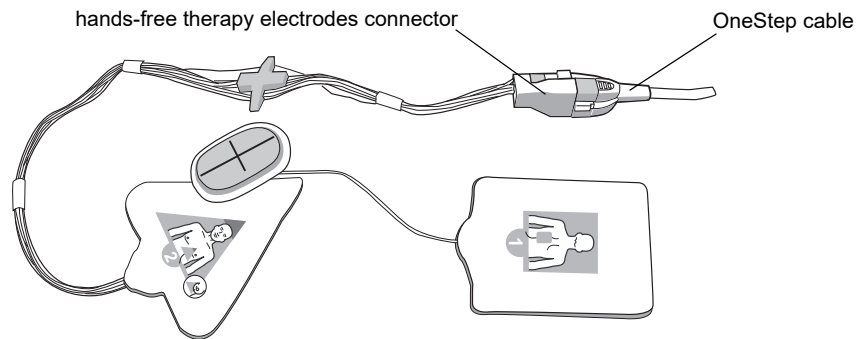

When connecting a OneStep electrode to the OneStep cable, push the two connectors together until the latch clicks, as shown.

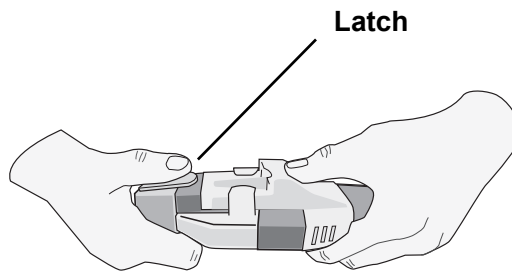

When disconnecting the OneStep electrode and OneStep cable, press down the latch with your thumb as shown.

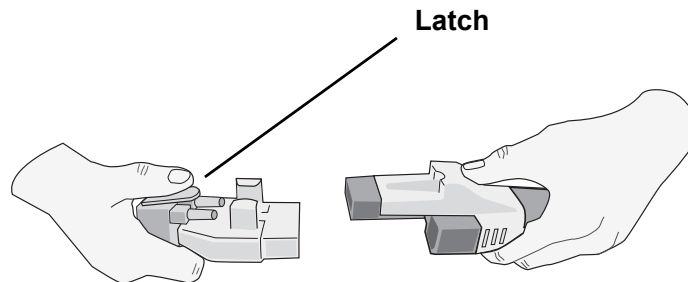

The message *ATTACH PADS* or *CHECK PADS* will be displayed and energy will not be delivered if the therapy electrodes are not making good contact with the patient or if a short circuit exists between the therapy electrodes.

Therapy Electrode Application

WARNING! Poor adherence and/or air under the therapy electrodes can lead to the possibility of arcing and skin burns.

1. Apply one edge of the pad securely to the patient.

- Roll the pad smoothly from the applied edge to the other, being careful not to trap any air pockets between the gel and skin.

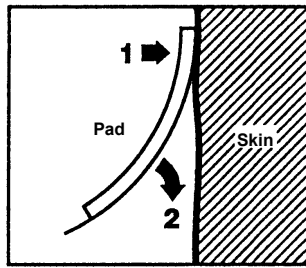

Note: If it is not possible to place the “BACK” pad on the patient’s back, the pads should be placed in the standard apex-sternum positions. Effective defibrillation will result, but pacing will usually be less effective.

1 Select ON

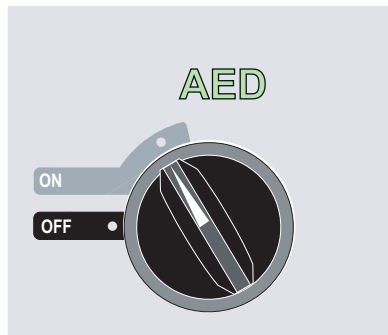

The unit beeps 4 times to indicate that it has passed the power on self test, and the green AED label and the ON mode selector light up on the front panel.

If no hands-free therapy electrodes have been attached to the patient and connected to the R Series, the *ATTACH PADS* message and voice prompt will be issued.



Energy Select

The default energy selections for adult patients are:

- Shock 1 - 120 joules

- Shock 2 - 150 joules
- Shock 3 - 200 joules

The default energy selections for pediatric patients are:

- Shock 1 - 50 joules
- Shock 2 - 70 joules
- Shock 3 - 85 joules

After the third shock, all subsequent shocks are delivered at the same energy as the third shock in both Adult and Pediatric modes.

2 Analyze

WARNING! Do not analyze the patient ECG during patient movement. A patient must be motionless during ECG analysis. Do not touch the patient during analysis. Cease all movement via stretcher or vehicle before analyzing the ECG.

The R Series automatically begins the analysis of the patient's ECG rhythm, displays an ANALYZING ECG message for 5 seconds, then announces and displays a *STAND CLEAR* message. If therapy electrodes have not been properly connected to the patient, an *ATTACH PADS* or *CHECK PADS* message is displayed and analysis will be inhibited.

Note: If the R Series has been configured to perform extra CPR, it displays a *CHECK PULSE* voice prompt and the message appears for 10 seconds. Then it displays an *IF NO PULSE, PERFORM CPR* message along with a voice prompt for the configured duration before analysis begins. You can start an ECG analysis during the CPR interval by pressing the **ANALYZE** softkey.



An ANALYZING ECG message is displayed while the patient's ECG is analyzed. Once the analysis is completed, the unit indicates whether or not a shock is advised.

WARNING! ECG rhythm analysis does not warn of patient asystole, which is not a shockable rhythm.

When a nonshockable rhythm is detected, the unit displays a *NO SHOCK ADV.* message. Immediately begin chest compressions and continue other treatment per protocol.

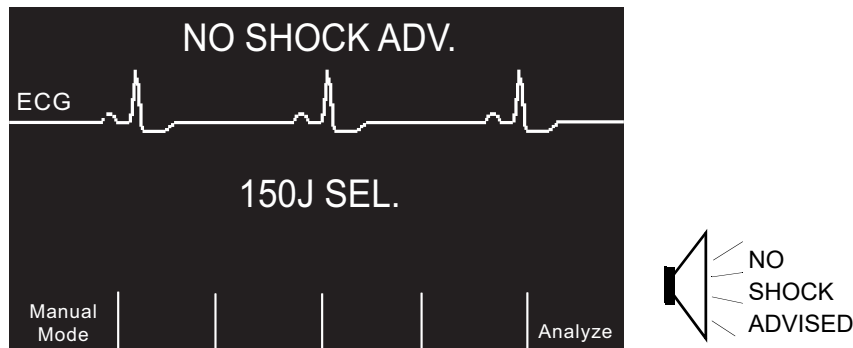

If the patient's rhythm is shockable, the unit displays a *SHOCK ADVISED* message. The defibrillator begins charging automatically to the preconfigured energy setting and displays a *CHARGING* message.

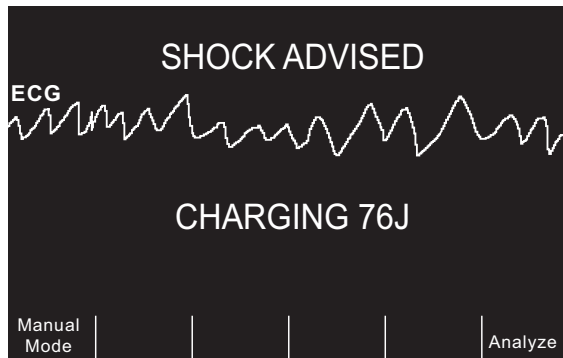

When charging is completed, the monitor displays the energy level to which the defibrillator has charged, *XXXJ READY*.

3 Press SHOCK

WARNING! Warn all persons in attendance of the patient to **STAND CLEAR** prior to defibrillator discharge.

Do not touch the bed, patient, or any equipment connected to the patient during defibrillation. A severe shock can result. Do not allow exposed portions of the patient's body to come in contact with metal objects, such as a bed frame, as unwanted pathways for defibrillation current may result.

Once the unit is charged to the selected energy, the **SHOCK** button illuminates and the *PRESS SHOCK* message is announced and displayed.

Note: Rhythm analysis does not continue after the defibrillator is charged and ready once a decision to shock has been made. The R Series unit will not automatically disarm the defibrillator if the patient's rhythm reverts to a non-shockable rhythm before the shock has been delivered.

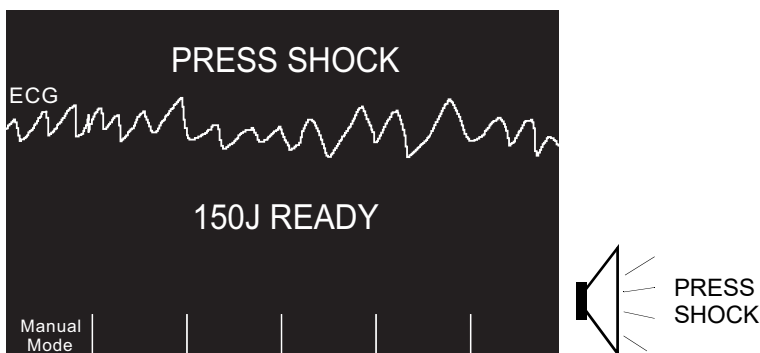

A continuous tone sounds for 20 seconds, followed by an intermittent tone for 10 seconds. You must deliver the shock within this 30 second interval, or the defibrillator will disarm itself.

Press and hold the illuminated **SHOCK** button on the front panel until energy is delivered to the patient.

Observe the patient or ECG response to verify that the shock has been delivered.

After the energy has been delivered to the patient, the display returns to *XXX J SEL*. *SHOCKS:1*, indicating the number of shocks delivered to the patient.

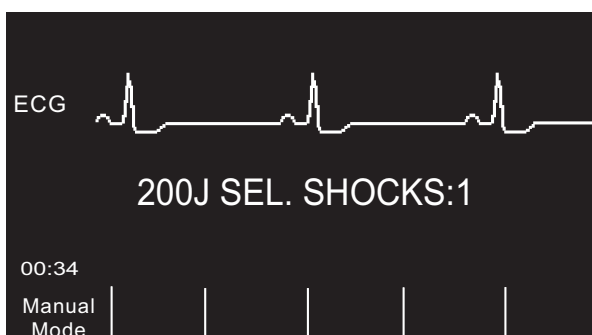

Perform CPR

Begin chest compressions and rescue breathing per local protocol as prompted by the unit.

Note: If OneStep CPR pads or OneStep Complete pads are connected, the unit monitors the rate and depth of chest compressions and can display *PUSH HARDER* and *GOOD COMPRESSIONS* messages and voice prompts.

If configured, the message *STOP CPR* appears 3 seconds before the end of the CPR interval.

Repeat Analysis

After performing CPR for the configured period of CPR, the unit will restart ECG analysis automatically.

Note: Reanalysis of the ECG rhythm is inhibited for 3 seconds after a shock.

Continue Patient Care

Continue patient care according to medical protocols.

Operating Messages

The unit uses both audio and visual prompts to present critical information to operators. The following information describes the unit default configuration. If your device has been custom configured, some of the information may be different.

There are 10 voice prompts used in AED mode. Most of these prompts are accompanied by a message displayed on the monitor. The voice prompts are given only once, but the monitor continues to display the message until new action is taken by the operator or the device status changes.

The unit will alternately display two different messages in the same field of the display when two conditions are detected at the same time. For example, a *LOW BATTERY* message may alternately display on the same line of the monitor as the *CHECK PADS* message.

Audio and Display Messages

The display messages and voice prompts that can occur during AED operation are described below.

ATTACH PADS

If the unit is powered on without therapy pads connected to the patient, the *ATTACH PADS* message is announced and displayed.

ANALYZING ECG/STAND CLEAR

The *ANALYZING ECG* message is displayed and the *STAND CLEAR* message is displayed and announced when the ECG analysis starts automatically or after pressing the **ANALYZE** softkey. They indicate that an active ECG analysis is in progress.

CHARGING XXXJ

ECG analysis is still in progress and a potentially shockable rhythm has been detected. The current charge level is displayed.

SHOCK ADVISED

A shockable rhythm has been detected and defibrillation is advised. The selected energy level has not yet been reached. The current energy level is displayed.

SHOCK ADVISED/ XXXJ READY

This message is displayed when a shockable ECG rhythm has been detected and the selected energy is ready to be delivered.

PRESS SHOCK

This message is displayed and announced when the ECG analysis has determined that a shock is advised and the selected energy is ready to be delivered.

SHOCKS: XX

This message displays the number of shocks that have been delivered by the unit since it was powered on. It resets to 0 after the unit has been off for more than 10 seconds.

NO SHOCK ADVISED

When ECG analysis detects a nonshockable rhythm, this message displays and continues for 10 seconds following completion of the analysis.

CHECK PULSE

If configured to do so, this message is displayed and announced in the following situations:

- After a No Shock Advised analysis result
- During the CPR interval after a No Shock Advised analysis result
- During the CPR interval after delivery of the final shock in a stacked shock sequence
- After the final shock is delivered

IF NO PULSE, PERFORM CPR

If configured to do so, this message is displayed and announced in the following situations:

- During the CPR interval after a No Shock Advised analysis result
- During the CPR interval after delivery of the final shock in a stacked shock sequence
- During the start of extra CPR interval

PERFORM CPR

If configured to do so, this message is displayed and announced in the following situations:

- During the CPR interval after a No Shock Advised analysis result
- During the CPR interval after delivery of the final shock in a stacked shock sequence

PUSH HARDER

This message is announced when the chest compressions applied during CPR are not forceful enough.

GOOD COMPRESSIONS

This message is announced when the chest compressions applied during CPR are forceful enough.

CHECK PADS

This message is displayed and announced when the therapy pads have been disconnected from the patient.

ELAPSED TIME

When enabled, this feature indicates the elapsed time since the unit was first turned on. It is displayed in the lower left corner. The elapsed time is displayed in MM:SS format up to 99:59. If the unit is on for over 100 minutes, the elapsed time will roll over to 0. The elapsed time will be maintained for up to 10 seconds after power down. This will give the operator adequate time to change the unit's battery without resetting the elapsed time.

FULLY RELEASE

If configured to do so, this message reminds rescuers to lift (fully release) their hands from the patient's chest during compressions to allow full recoil. By default, this feature is not enabled.

MONITOR

The *MONITOR* message appears when the ECG cable is connected to its input connector and attached to the patient, but the therapy electrodes are not connected. The unit selects lead II and sets the ECG size automatically (you cannot change the Lead and ECG size).

Switching to Manual Mode Operation

Press the **Manual Mode** softkey on the front panel of the unit to enter the Manual mode of operation.



The message *CONFIRM MANUAL MODE* and the **Confirm** softkey will be displayed. Press the **Confirm** softkey to enter the Manual mode of operation. If the **Confirm** softkey is not pressed within 10 seconds, the unit will revert back to AED operation.

Note: If the unit has been configured not to confirm the transition from AED mode to Manual mode, the unit will immediately enter Manual mode.

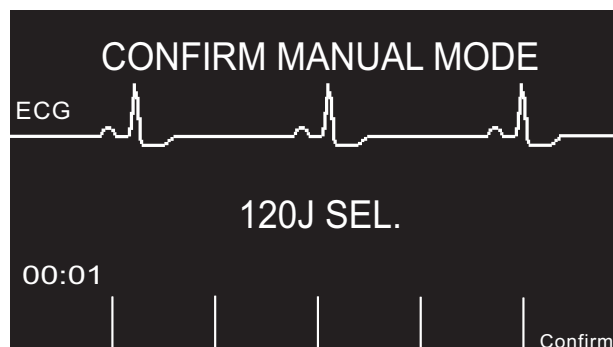

When changing from AED mode to Manual mode, the current selected energy level is maintained.

Note: To transfer back to AED mode from Manual mode, power down the unit for more than 10 seconds and then power it back up.

(This page intentionally left blank.)

Chapter 4

Manual Defibrillation



Paddles are a defibrillation-protected Type BF patient connection.



ECG leads are a defibrillation-protected Type CF patient connection.

Emergency Defibrillation Procedure with Paddles

WARNING! To avoid risk of electrical shock, do not allow electrolyte gel to accumulate on hands or paddle handles.

When defibrillating with paddles, use your thumbs to operate the **SHOCK** buttons in order to avoid inadvertent operator shock. No portion of the hands should be near the paddle plates.

Determine the Patient's Condition Following Local Medical Protocols

Verify:

- Unconsciousness.
- Absence of breathing.
- Absence of pulse.

Begin CPR Following Local Medical Protocols

Request additional assistance.

1 Select ON

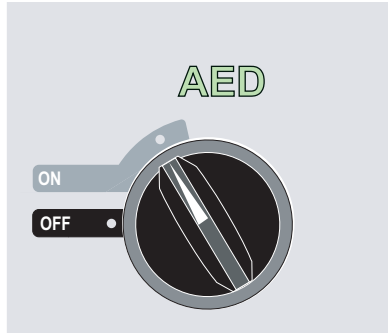

The unit beeps 4 times to indicate that it has passed the power on self test, and the green AED label and the ON mode selector light up on the front panel.

Press the **Manual Mode** softkey on the front panel of the unit to enter the Manual mode of operation.

The message *CONFIRM MANUAL MODE* and the **Confirm** softkey will be displayed. Press the **Confirm** softkey to enter the Manual mode of operation. If the **Confirm** softkey is not pressed within 10 seconds, the unit will revert back to AED operation.

Note: If the unit has been configured not to confirm the transition from AED mode to Manual mode, the unit will immediately enter Manual mode.

The control buttons for Manual mode light up on the front panel and the unit automatically defaults to 120 joules or the preconfigured first shock energy selection.

Note: Defibrillator PADDLES are selected as the ECG source when the instrument is changed to Manual mode with paddles connected to the OneStep cable.

Energy Select

Look at the Display and verify the energy is appropriate. Unless internal handles are connected to the OneStep cable, the default energy selections for adult patients are:

- Shock 1 - 120 joules
- Shock 2 - 150 joules
- Shock 3 - 200 joules

If medical protocol allows, you may select a different energy level using the up and down arrow buttons. One pair is located on the front panel of the unit; the other pair is located on the sternum paddle.

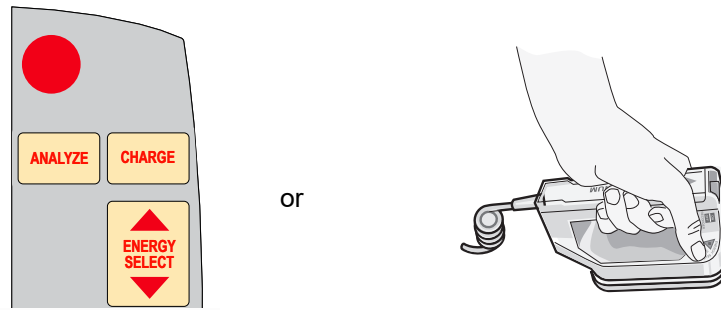

Note: Neonatal and pediatric defibrillator energy levels should be selected based on site-specific protocols.

The selected energy level is shown as *DEFIB XXXJ SEL.* on the display.

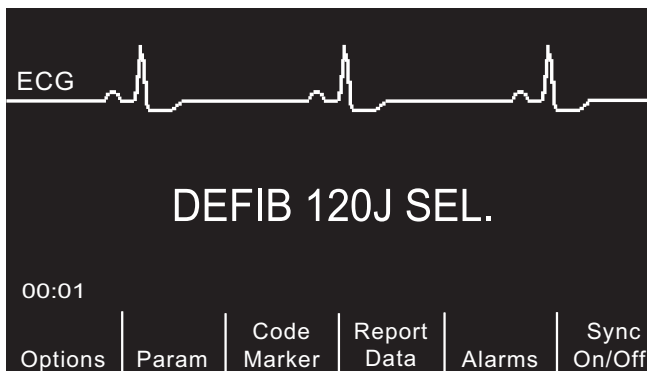

If you have configured Shocks 1, 2, and 3 to escalating energy levels (see the *R Series Configuration Guide* for instructions), the R Series automatically sets the energy to the preconfigured Energy Level: Shock 1, 2, 3 setting at power-up and after each of the first two shocks. The *ENERGY INCREMENTED* message will be displayed after Shocks 1 and 2 are delivered. Manually changing the energy level outside the preprogrammed sequence and delivering a shock disables the automatic escalation function.

Prepare Paddles

Release the paddles, apply a liberal amount of electrolyte gel to the electrode surface of each paddle, and rub the electrode surfaces together to evenly distribute the applied gel. (You can substitute electrode gel patches for the gel.)

Apply Paddles to Chest

Apply the paddles firmly to the anterior wall of the chest. Place the sternum paddle to the right of the patient's sternum (patient's right), just below the clavicle.

Place the apex paddle on the chest wall, just below and to the left of the patient's left nipple, along the anterior-axillary line.

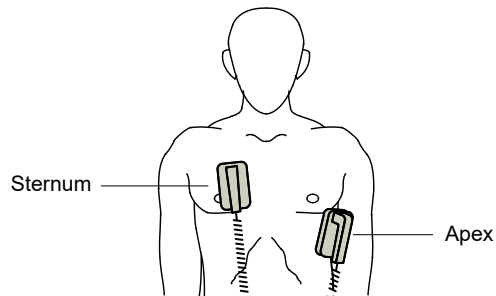

Rub the paddles against the skin to maximize the paddle-to-patient contact.

WARNING! Do not permit gel to accumulate between the paddle electrodes on the chest wall (gel bridge). This could cause burns and reduce the amount of energy delivered to the heart.

If using defibrillator gel pads, make sure that the size of the pad is large enough to cover the entire paddle electrode area.

The paddles may be used for ECG monitoring in emergency situations when time does not allow connection of standard ECG monitoring electrodes.

If an ECG cable and ECG electrodes are in use, press the **LEAD** button to select the desired ECG lead.

2 Charge Defibrillator

Press the **CHARGE** button on the apex handle or on the front panel.

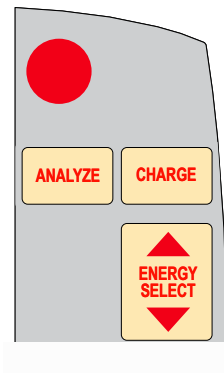

or

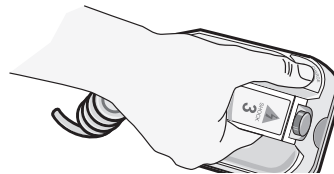

The **Report Data** softkey then changes to **DISARM**. If both **SHOCK** buttons on the paddles are depressed when the **CHARGE** button is activated, the unit does not charge and a *RELEASE SHOCK BUTTON* message appears on the display.

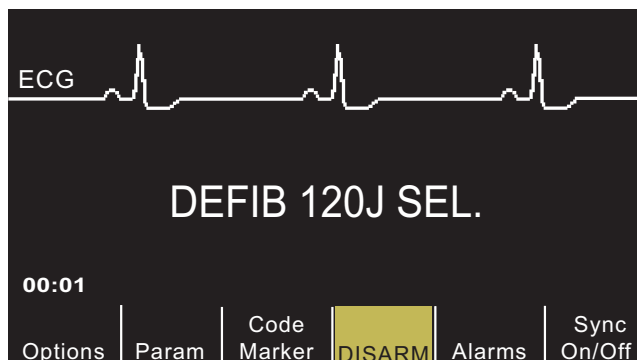

To increase or decrease the selected energy after you have pressed the **CHARGE** button, use the defibrillator **ENERGY SELECT** buttons on either the sternum paddle or the defibrillator front panel.

To disarm the defibrillator without delivering a shock, press the **DISARM** softkey. The softkey field then changes back to **Report Data**.

Caution Changing the selected energy while the unit is charging or charged causes the defibrillator to disarm itself. Press the **CHARGE** button again to charge the unit to the newly selected energy level.

After charging to the selected energy, the charge indicator on the apex paddle lights. A distinctive charge ready tone sounds, and the message *DEFIB XXXJ READY* is displayed. The defibrillator is now ready to discharge.

3 Deliver Shock

WARNING! Warn all persons in attendance of the patient to **STAND CLEAR** prior to defibrillator discharge.

Do not touch the bed, patient, or any equipment connected to the patient during defibrillation. A severe shock can result. Do not allow exposed portions of the patient's body to come into contact with metal objects, such as a bed frame, as unwanted pathways for defibrillation current may result.

Apply a force of 10 - 12 kilograms (22 - 26.4 pounds) to each paddle in order to minimize patient impedance and achieve optimal results.

Using your thumbs, simultaneously press and hold both **SHOCK** buttons (one on each paddle) until energy is delivered to the patient.

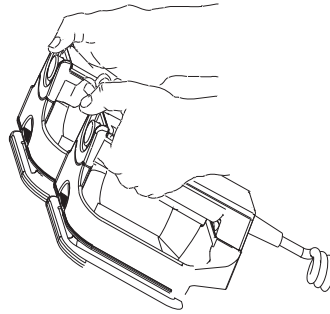

Caution Use only thumbs to depress the **SHOCK** buttons. Failure to do so could result in the inadvertent depression of the **ENERGY SELECT** buttons, causing the defibrillator to disarm itself.

Once the energy is delivered, the display simultaneously shows *XXXJ DELIVERED* and *DEFIB XXXJ SEL. SHOCKS: XX*. After approximately 5 seconds, the *XXXJ DELIVERED* message disappears, and the *DEFIB XXXJ SEL. SHOCKS: XX* message remains to indicate the selected energy level.

Note: If the defibrillator is not discharged within 60 or 120 seconds (user configurable) after reaching the selected energy level, the unit automatically disarms itself.

During the 10 seconds prior to disarming, the charge ready tone beeps intermittently. The charge ready tone then stops, the charge indicator light goes off, and the monitor message changes to *DEFIB XXXJ SEL*. Press the **CHARGE** button to recharge the unit.

Autoclavable External Paddles

ZOLL Autoclavable External Paddles are available for use with manually operated ZOLL defibrillators when sterile conditions must be maintained during defibrillation.

Emergency Defibrillation Procedure with Hands-Free Therapy Electrodes



ZOLL hands-free therapy electrodes are a defibrillation-protected Type BF patient connection.



ECG leads are a defibrillation-protected Type CF patient connection.

Determine the Patient's Condition Following Local Medical Protocols

Verify:

- Unconsciousness.
- Absence of breathing.
- Absence of pulse.

Begin CPR Following Medical Protocols

Request additional assistance.

Prepare Patient

Remove all clothing covering the patient's chest. Dry chest if necessary. If the patient has excessive chest hair, clip or shave it to ensure proper adhesion of the electrodes.

Attach hands-free therapy electrodes according to instructions on the electrode packaging.

Ensure that the therapy electrodes are making good contact with the patient's skin and are not covering any part of the ECG electrodes.

Connect the hands-free therapy electrodes to the OneStep cable if not preconnected.

When connecting a OneStep electrode to the OneStep cable, push the two connectors together until the latch clicks, as shown.

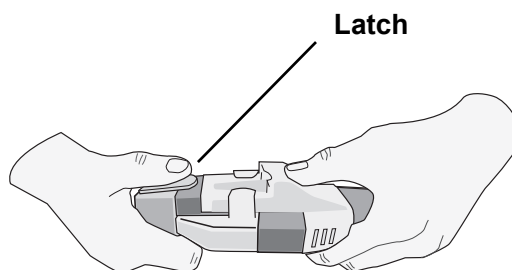

When disconnecting the OneStep electrode and OneStep cable, press down the latch with your thumb as shown.

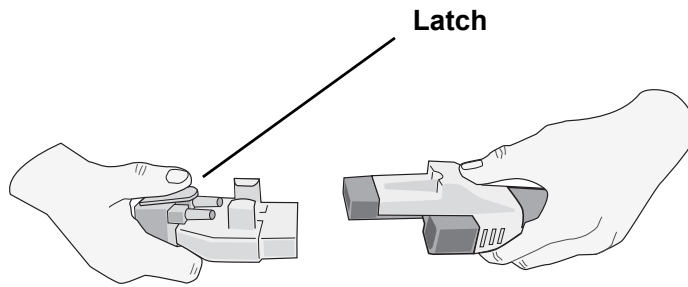

If defibrillation electrodes are not making good contact with the patient's skin, the unit issues the messages *CHECK PADS* and *POOR PAD CONTACT* and does not allow delivery of energy. If a short circuit exists between the electrodes, the unit issues the message *DEFIB PAD SHORT*.

Therapy Electrode Application

WARNING! Poor adherence and/or air under the therapy electrodes can lead to the possibility of arcing and skin burns.

1. Apply one edge of the pad securely to the patient.
2. Roll the pad smoothly from the applied edge to the other, being careful not to trap any air pockets between the gel and skin.

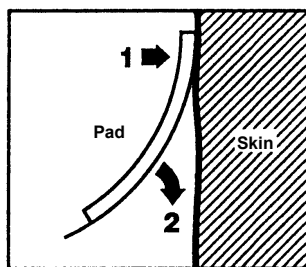

Note: If it is not possible to place the “BACK” electrode on the patient's back, place the electrodes in the standard apex-sternum positions. Effective defibrillation results, but pacing will usually be less effective.

WARNING! Application of adult electrodes to a pediatric patient will result in the automatic selection of adult energy levels. If needed, manually adjust the energy settings based on site-specific protocols.

1 Select ON

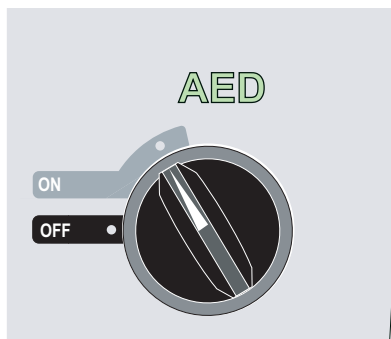

The unit beeps 4 times to indicate that it has passed the power on self test, and the green AED label and the ON mode selector light up on the front panel.

Press the **Manual Mode** softkey on the front panel of the unit to enter the Manual mode of operation.

The message *CONFIRM MANUAL MODE* and the **Confirm** softkey will be displayed. Press the **Confirm** softkey to enter the Manual mode of operation. If the **Confirm** softkey is not pressed within 10 seconds, the unit will revert back to AED operation.

Note: If the unit has been configured not to confirm the transition from AED mode to Manual mode, the unit will immediately enter Manual mode.

The control buttons for Manual mode light up on the front panel and the unit automatically defaults to 120 joules or the preconfigured first shock energy selection.

PADS are selected as the ECG source when the instrument is turned to Manual mode and paddles are not connected to the OneStep cable. You may select any of the other ECG leads by pressing the front panel LEAD button.

Energy Select

Look at the display, and verify the selected energy is appropriate. The default energy selections for adult patients are:

- Shock 1 - 120 joules
- Shock 2 - 150 joules
- Shock 3 - 200 joules

When used with OneStep Pediatric electrodes, the default energy selections are:

- Shock 1 - 50 joules
- Shock 2 - 70 joules
- Shock 3 - 85 joules

WARNING! When used with other pediatric defibrillation electrodes, defibrillator energies must be set manually based on site-specific institutional protocols for pediatric defibrillation.

After the third shock, all subsequent shocks are delivered at the same energy as the third shock in both Adult and Pediatric modes.

If medical protocol allows, you may select a different energy level using the **ENERGY SELECT** buttons on the front panel.

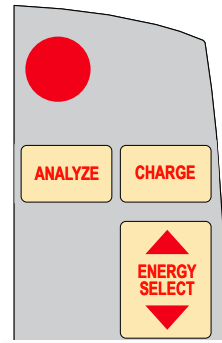

The selected energy level is shown as *DEFIB XXXJ SEL.* on the display.

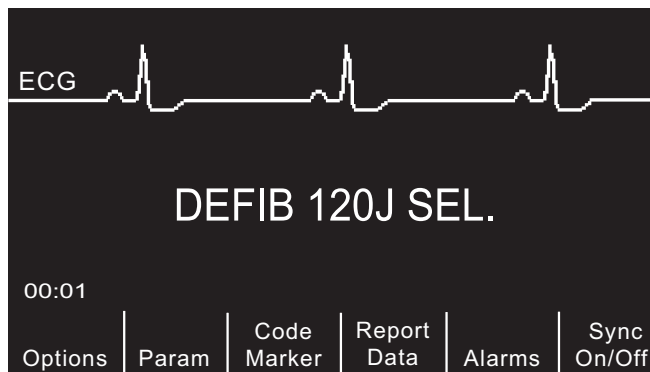

If you have configured Shocks 1, 2, and 3 to escalating energy levels (see the *R Series Configuration Guide* for instructions), the R Series automatically sets the energy to the preconfigured Energy Level: Shock 1, 2, 3 setting at power-up and after each of the first two shocks. The *ENERGY INCREMENTED* message will be displayed after Shocks 1 and 2 are delivered. Manually changing the energy level outside the preprogrammed sequence and delivering a shock disables this function.

2 Charge Defibrillator

Press the **CHARGE** button on the front panel.

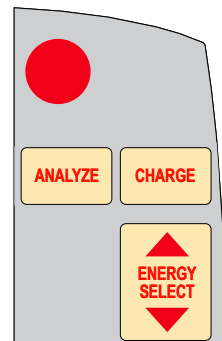

The **Report Data** softkey then changes to **DISARM**. To increase or decrease the selected energy after you have pressed the **CHARGE** button, use the defibrillator **ENERGY SELECT** buttons.



To disarm the defibrillator without delivering a shock, press the **DISARM** softkey. The softkey field then changes back to **Report Data**.

Caution Changing the selected energy while the unit is charging or charged causes the defibrillator to disarm itself. Press the **CHARGE** button again to charge the unit.

After charging to the selected energy, the **SHOCK** button on the front panel lights. A distinctive charge ready tone sounds and the *DEFIB XXXJ READY* is displayed. The defibrillator is now ready to discharge.

3 Deliver Shock

WARNING! Warn all persons in attendance of the patient to **STAND CLEAR** prior to defibrillator discharge.

Do not touch the bed, patient, or any equipment connected to the patient during defibrillation. A severe shock can result. Do not allow exposed portions of the patient's body to come into contact with metal objects, such as a bed frame, as unwanted pathways for defibrillation current may result.

Press and hold the **SHOCK** button until energy is delivered to the patient.

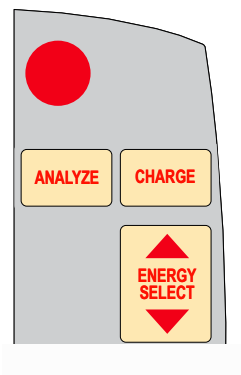

Note: If the defibrillator is not discharged within 60 or 120 seconds (user configurable) after reaching the selected energy level, the unit automatically disarms itself.

During the 10 seconds prior to disarming, the charge ready tone beeps intermittently. The charge ready tone then stops, the **SHOCK** button light goes off, and the monitor message changes to *DEFIB XXXJ SEL*. Press the **CHARGE** button to recharge the unit.

Once the energy is delivered, the display simultaneously shows *XXXJ DELIVERED* and *DEFIB XXXJ SEL. SHOCKS: XX*. After approximately 5 seconds, the *XXXJ DELIVERED* message disappears, and the *DEFIB XXXJ SEL. SHOCKS: XX* message remains to indicate the selected energy level.

Autoclavable Electrodes

ZOLL Autoclavable Internal Handles are designed for use with a manually operated ZOLL defibrillator to defibrillate the heart during open chest procedures. Two types of Autoclavable Internal Handles are available:

- Molded Autoclavable Internal handles with integrated electrode spoons
- Autoclavable Internal Handles with removable internal defibrillation electrodes

When these internal handles are used, the R Series defibrillator can operate only in Manual mode even if the unit supports Advisory mode. When an internal handle set is connected to the R Series, it automatically limits energy output to a maximum of 50 joules.

For step-by-step procedures for open chest defibrillation as well as important cleaning and sterilization of the autoclavable electrodes, refer to the *Autoclavable Internal Handle and Electrode Operator's Guide*.

Chapter 5

Advisory Defibrillation



ZOLL hands-free therapy electrodes are a defibrillation-protected Type BF patient connection.

When the Mode Selector is turned to ON, the unit is in Manual mode, and hands-free therapy electrodes are used, the R Series can identify shockable rhythms using its built in ECG analysis capability. You must read the advisory messages, charge the defibrillator to the preconfigured or user-selected energy level (if automatic charge is disabled), and deliver treatment to the patient when required by protocol and patient condition.

The advisory function can be activated only when:

- Hands-free therapy electrodes are connected and selected as the ECG source.
- Hands-free therapy electrodes are properly connected to the patient.
- The Mode Selector is turned to ON and the unit is in Manual mode.

WARNING! Use only pediatric electrodes to defibrillate patients under 8 years of age in Advisory mode. Use of adult electrodes with pediatric patients can result in the delivery of excessive energy doses.

Advisory Defibrillation Procedure

Determine the Patient's Condition Following Local Medical Protocols

Verify:

- Unconsciousness.
- Absence of breathing.
- Absence of pulse.

Begin CPR Following Local Medical Protocols

Request additional assistance.

Prepare Patient

Remove all clothing covering the patient's chest. Dry chest if necessary. If the patient has excessive chest hair, clip or shave it to ensure proper adhesion of the electrodes.

Attach hands-free therapy electrodes according to instructions on the electrode packaging and as described in "Therapy Electrode Application" on page 4-8.

Ensure that the electrodes are making good contact with the patient's skin and are not covering any part of the ECG electrodes.

If therapy electrodes are not making good contact with the patient's skin, the unit issues the messages *CHECK PADS* and *POOR PAD CONTACT* and does not allow delivery of energy. If a short circuit exists between the electrodes, the unit issues the message *DEFIB PAD SHORT*.

1 Select ON

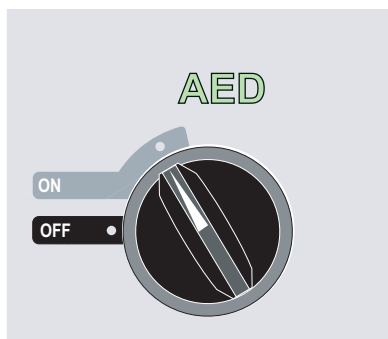

The unit beeps 4 times to indicate that it has passed the power on self test, and the green AED label and the ON mode selector light up on the front panel.

Press the **Manual Mode** softkey on the front panel of the unit to enter the Manual mode of operation.

The message *CONFIRM MANUAL MODE* and the **Confirm** softkey will be displayed. Press the **Confirm** softkey to enter the Manual mode of operation. If the **Confirm** softkey is not pressed within 10 seconds, the unit will revert back to AED operation.

Note: If the unit has been configured not to confirm the transition from AED mode to Manual mode, the unit will immediately enter Manual mode.

The control buttons for Manual mode light up on the front panel and the unit displays *DEFIB 120J SEL* on the monitor.

Energy Select

The default energy selections for adult patients are:

- Shock 1 - 120 joules
- Shock 2 - 150 joules
- Shock 3 - 200 joules

When used with OneStep Pediatric electrodes, the default energy selections for pediatric patients are:

- Shock 1 - 50 joules
- Shock 2 - 70 joules
- Shock 3 - 85 joules

WARNING! Use only OneStep Pediatric electrodes to defibrillate patients under 8 years of age in Advisory mode. Use of adult electrodes, or pediatric electrodes other than OneStep Pediatric electrodes, can result in the delivery of excessive energy doses.

After the third shock, all subsequent shocks are delivered at the same energy as the third shock in both Adult and Pediatric modes.

If medical protocols allow, you may select a different energy level using the energy select up and down arrow buttons on the front panel. The new energy setting displays on the monitor.

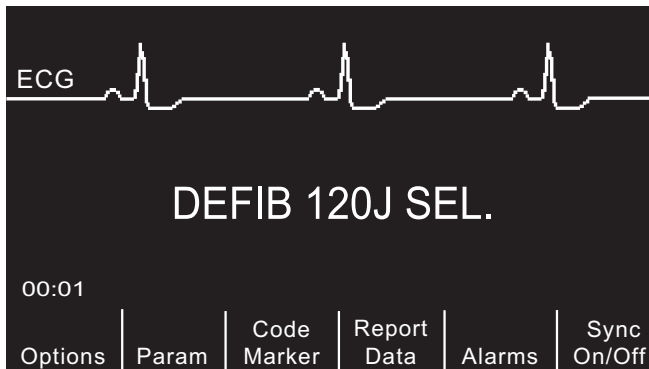

If you have configured SHOCK 1, 2, and 3 to escalating energy levels, and then you manually change the energy level outside preconfigured SHOCK 1, 2, 3 sequence and deliver a shock, it disables the automatic energy escalation. See the Energy Level: Shock 1, 2, 3 section of the *R Series Configuration Guide* for more details.

2 Press ANALYZE Button

WARNING! Keep patient motionless during ECG analysis. Do not touch the patient during analysis. Cease all movement via stretcher or vehicle before analyzing the ECG.

Press the **ANALYZE** button to begin the analysis of the patient's ECG rhythm and to determine if a shockable rhythm is present.

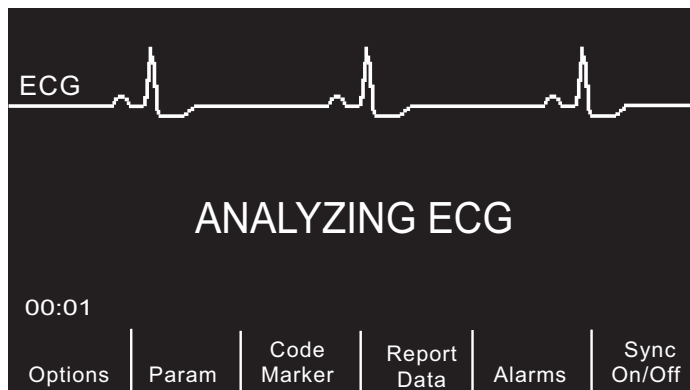

An *ANALYZING ECG* message is displayed for 6 to 12 seconds while the patient's ECG is analyzed. Once the analysis is completed, the unit indicates whether or not a shock is advised.

The analysis normally consists of three consecutive 3-second ECG rhythm analyses. If at least two of the three analyses determine that the patient has a shockable rhythm, the unit automatically charges to the preconfigured energy level and prompts the operator to shock the patient. If two or more of the three 3-second ECG analyses do not detect a shockable rhythm, the unit alerts the operator that no shock is advised.

WARNING! ECG rhythm analysis does not warn of patient asystole, which is not a shockable rhythm.

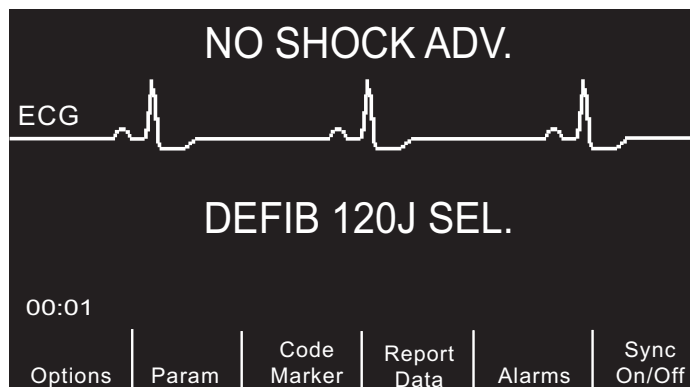

When a nonshockable rhythm is detected, the unit displays a *NO SHOCK ADV.* message. Follow the local protocols to continue CPR or other life support, and re-analyze the ECG at appropriate intervals.

Note: When a nonshockable rhythm is detected, the R Series does not prevent the user from manually defibrillating the patient.

When a shockable rhythm is detected (ventricular fibrillation or wide-complex tachycardia with heart rate > 150), one of the following occur:

- Units with the automatic charge option enabled automatically charge to the preconfigured or user selected energy setting.
- Units with the automatic charge option disabled will alternately display the messages *SHOCK ADVISED* and *PRESS CHARGE*. Press the **CHARGE** button.

Regardless of the analysis result, the user can control the defibrillator manually. For example, the user can defibrillate the patient even if the advisory function issues a NO SHOCK ADV. message.

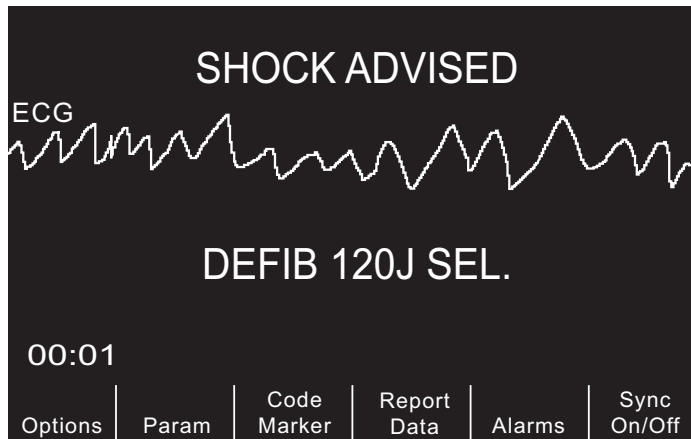

3 Press SHOCK

WARNING! Warn all persons in attendance of the patient to **STAND CLEAR** prior to defibrillator discharge.

Do not touch the bed, patient, or any equipment connected to the patient during defibrillation. A severe shock can result. Do not allow exposed portions of the patient's body to come in contact with metal objects, such as a bed frame, as unwanted pathways for defibrillation current may result.

Once the unit is charged to the selected energy, the **SHOCK** button illuminates and the *PRESS SHOCK* message is displayed. Simultaneously, the monitor displays the energy level to which the defibrillator is charged, *DEFIB XXXJ READY*.

Note: Rhythm analysis does not continue after the defibrillator is charged and ready once a decision to shock has been made. The R Series unit will not automatically disarm the defibrillator if the patient's rhythm reverts to a non-shockable rhythm before the shock has been delivered.



A continuous tone sounds for 50 seconds, followed by an intermittent beeping for 10 seconds. You must deliver the shock within this 60 second interval, or the defibrillator will disarm itself.

Note: This interval is user configurable and can be set to either 60 or 120 seconds.

Press and hold the illuminated **SHOCK** button on the front panel until energy is delivered to the patient. An *XXXJ DELIVERED* message appears on the display for approximately 5 seconds.

Watch the patient or ECG response to verify that the shock has been delivered.

After the energy has been delivered to the patient, the display returns to *DEFIB XXX J SEL*.

Perform CPR

Begin chest compressions and rescue breathing per local protocol.

If configured, the message *STOP CPR* appears 3 seconds before the end of the CPR interval.

Repeat Analysis

Press the **ANALYZE** button to restart an ECG analysis and determine if additional shocks are required.

Note: Reanalysis of the ECG rhythm is inhibited for 3 seconds after each shock.

Continue Patient Care

Continue patient care according to medical protocols.

Advisory Function Messages

SELECT DEFIB MODE

Displayed if any of the buttons on the right side front panel (**SHOCK**, **ANALYZE**, **CHARGE**, **ENERGY SELECT**) are pressed while in Data Transfer mode. To enable the defibrillator in Manual mode, press the **Exit Transfer** softkey, or quickly turn the Mode Selector to **OFF** and then **ON**.

SELECT PADS

Displayed if the **ANALYZE** button is pressed while the device is operating in any ECG lead other than “PADS.” Press the **LEAD** button until “PADS” is selected.

REMOVE SYNC

Displayed if the **ANALYZE** button is pressed while the device is in Sync mode. Turn off Sync mode by pressing the **Sync On/Off** softkey. Press the **ANALYZE** button again to initiate ECG rhythm analysis.

Warning Messages

Warning messages prompt the operator to check the patient, the unit, the electrodes and/or connections.

NOISY ECG / RETRY ANALYSIS

A *NOISY ECG* message alternating with a *RETRY ANALYSIS* message is displayed for 5 seconds when the unit detects a noisy ECG signal during ECG analysis. Check and adjust electrode placement and cable connections to help eliminate the noise source. Keep patient motionless during ECG analysis. Press the **ANALYZE** button again to begin ECG analysis.

CHECK PATIENT

The unit has detected a shockable rhythm during continuous background ECG analysis (i.e., Smart Alarms™). The prompt is given only when the heart rate alarms are enabled and the unit detects a shockable rhythm. The screen message persists as long as a shockable rhythm is being detected. Press the **ANALYZE** button to begin ECG analysis.

Note: This CHECK PATIENT analysis function operates continuously when heart rate alarms are enabled and does not require pressing the **ANALYZE** button for operation.

CHECK PADS / POOR PAD CONTACT

The therapy electrodes are not properly attached to the patient, or the cable connections have become loose.

Check that the therapy electrodes are making good contact with the patient’s skin and that all cables are securely connected. This voice prompt will not sound if the therapy electrodes were not previously connected to the patient.

(This page intentionally left blank.)

Chapter 6

Synchronized Cardioversion

Note: This option is only available in Manual mode.



Paddles are a defibrillation-protected Type BF patient connection.



ECG leads are a defibrillation-protected Type CF patient connection.

WARNING! Only skilled personnel trained in Advanced Cardiac Life Support and familiar with equipment operation should perform synchronized cardioversion. The precise cardiac arrhythmia must be determined before attempting defibrillation or cardioversion.

Before attempting synchronized cardioversion, ensure that ECG signal quality is sufficient to minimize the risk of synchronizing on artifact.

Certain arrhythmias, such as ventricular tachycardia, atrial fibrillation, and atrial flutter, require synchronizing the defibrillator discharge with the ECG R-wave to avoid the induction of ventricular fibrillation. In this case, a synchronizing (Sync) circuit within the defibrillator detects the patient's R-waves. When the **SHOCK** button (or buttons, if using paddles) is pressed and held, the unit discharges with the next detected R-wave, thus avoiding the vulnerable T-wave segment of the cardiac cycle.

When in the Sync mode, the unit displays markers (↓) above the ECG trace to indicate the points in the cardiac cycle (R waves) where discharge can occur.

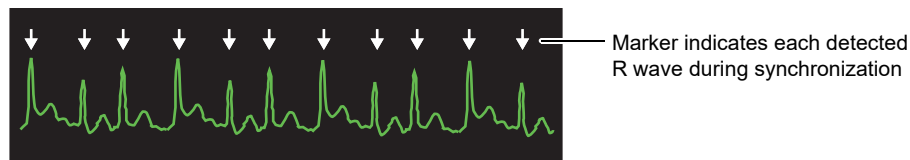

Verify that markers are clearly visible on the monitor and their location is appropriate and consistent from beat to beat. If necessary, use the **LEAD** and **SIZE** buttons to establish settings that yield the most consistent Sync marker pattern.

The **Sync On/Off** softkey is highlighted for clearer visibility. To turn off this feature, refer to the *R Series Configuration Guide*.



The synchronized cardioversion procedure for ZOLL hands-free therapy electrodes is identical to that for paddles with the exception of the **SHOCK** button location.

The R Series defibrillator supports two types of synchronized cardioversion:

- **Synchronized Cardioversion** — The R Series monitors the patient’s ECG and synchronizes shock delivery with this ECG source. For instructions, refer to “Synchronized Cardioversion Procedure” below.
- **Remote Synchronized Cardioversion** — An external device (such as a patient monitor) monitors the patient’s ECG and provides a synchronization pulse to the R Series’ Sync In/Marker Out connector. The R Series synchronizes shock delivery with these external pulses.

Note: When using the Remote Sync function, the procedure and displayed information are different. Make sure to follow the instructions for Remote Synchronized Cardioversion on page 6-5.

Synchronized Cardioversion Procedure

Determine the Patient’s Condition and Provide Care Following Local Medical Protocols

Prepare Patient

Remove all clothing covering the patient’s chest. Dry chest if necessary. If the patient has excessive chest hair, clip or shave it to ensure proper adhesion of the electrodes.

Attach ECG electrodes as described in “Monitoring Electrodes Attachment” on page 10-3.

A standard ECG cable and ECG electrodes are recommended for use during cardioversion. Hands-free therapy electrodes may be used as an ECG source. Signal quality will be equal to that of standard leads except immediately following a discharge when there may be more noise due to muscle tremors, especially if an electrode is not in complete contact with the skin.

Attach hands-free therapy electrodes according to instructions on the electrode packaging and as described in “Therapy Electrode Application” on page 4-8.

Ensure that the therapy electrodes are making good contact with the patient’s skin and are not covering any part of any other electrodes.

Connect the hands-free therapy electrodes to the OneStep cable if not preconnected.

If therapy electrodes are not making good contact with the patient’s skin, the unit issues the messages *CHECK PADS* and *POOR PAD CONTACT* and does not allow delivery of energy. If a short circuit exists between the electrodes, the unit issues the message *DEFIB PAD SHORT*.

An *ECG LEAD OFF* condition prevents synchronized discharge if leads are selected as the ECG source. This condition does not prevent the use of the defibrillator; it simply prevents use in a synchronized manner.

If paddles are being used for synchronized cardioversion, refer to “Emergency Defibrillation Procedure with Paddles” on page 4-1 for preparing paddles, applying paddles, charging the defibrillator, and delivering a shock. Note, however, that synchronized discharge with paddles as an ECG source is discouraged since the artifact induced by moving the paddles may resemble an R-wave and trigger defibrillator discharge at the wrong time.

1 Select ON

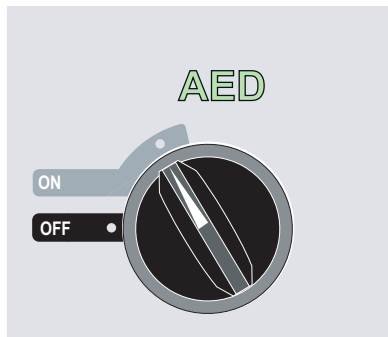

The unit beeps 4 times to indicate that it has passed the power on self test, and the green AED label and the ON mode selector light up on the front panel.

Press the **Manual Mode** softkey on the front panel of the unit to enter the Manual mode of operation.

The message *CONFIRM MANUAL MODE* and the **Confirm** softkey will be displayed. Press the **Confirm** softkey to enter the Manual mode of operation. If the **Confirm** softkey is not pressed within 10 seconds, the unit will revert back to AED operation.

Note: If the unit has been configured not to confirm the transition from AED mode to Manual mode, the unit will immediately enter Manual mode.

The control buttons for Manual mode light up on the front panel. Select the desired energy using the up and down arrow keys on the front panel (or sternum paddle if using paddles).

Press the Sync On/Off softkey

Your system will be in Sync mode once you press the **Sync On/Off** softkey if your R Series is not configured to support Remote Sync. However, if your R Series is configured to support

Remote Sync, pressing the **Sync On/Off** softkey will cause two other softkeys to be displayed: **Remote Sync** and **Sync**. Press the **Sync** softkey to enter Sync mode.

The selected energy level is displayed on the monitor.

A Sync marker (↓) appears on the monitor above each detected R-wave to indicate where discharge will occur.

Verify that the markers are clearly visible on the monitor and their location is appropriate and consistent from beat to beat. If necessary, use the **LEAD** and **SIZE** buttons to establish settings that yield the best display.

A *SYNC XXXJ SEL.* message appears on the display. If *DEFIB XXXJ SEL.* appears, press the **Sync On/Off** softkey. (If your unit supports Remote Sync, you must also press the **Sync** softkey.) Two quick beeps sound.

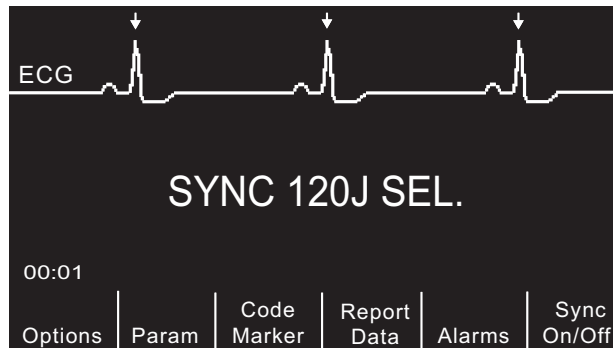

Unless otherwise configured, the unit automatically exits Sync mode after each shock and when the Mode Selector is moved to **PACER** or **OFF**.

To reactivate Sync mode, press the **Sync On/Off** softkey again. (If your unit supports Remote Sync, press the **Sync** softkey again.) Changing the selected energy levels does not cause the unit to leave Sync mode.

Note that the unit can be configured to stay in Sync mode after defibrillation, if desired. Refer to the *R Series Configuration Guide* for instructions.

2 Charge Defibrillator

Press the **CHARGE** button on the front panel or on the apex paddle handle.

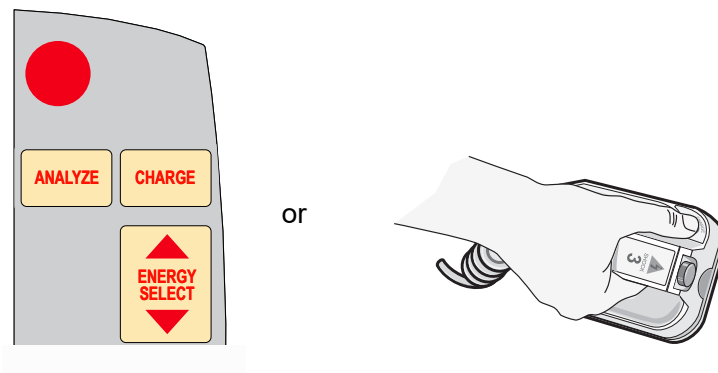

To abort charging and increase or decrease the selected energy after the **CHARGE** button has been pressed, use the **ENERGY SELECT** buttons on either the defibrillator front panel or the

sternum paddle. Press the **CHARGE** button again to charge the unit to the newly selected energy level.

After charging the unit to the selected energy, either the front panel **SHOCK** button or the APEX paddle charge indicator illuminates. A distinctive audible tone sounds and the *SYNC XXXJ READY* message is displayed.

The defibrillator is now ready to deliver therapy.

3 Deliver SHOCK

WARNING! Warn all persons in attendance of the patient to **STAND CLEAR** prior to defibrillator discharge.

Verify that no one is in contact with the patient, monitoring cable or leads, bed rails, or any other potential current pathways.

Verify that the ECG waveform is stable and that Sync markers appear over each R-wave.

Press and hold the illuminated **SHOCK** button on the front panel, (or simultaneously press and hold both paddle **SHOCK** buttons) until energy is delivered to the patient. The defibrillator will discharge with the next detected R wave.

Note: If the defibrillator is not discharged within 60 or 120 seconds (user configurable) after reaching the selected energy level, the unit automatically disarms itself. During the ten seconds prior to this internal disarm, the charge ready tone beeps intermittently. The charge ready tone then stops, and the defibrillator remains in Sync mode.

Once the energy is delivered, the display simultaneously shows *XXXJ DELIVERED* and *DEFIB XXXJ SEL*. After approximately 5 seconds, the *XXXJ DELIVERED* message disappears and the *DEFIB XXXJ SEL* message remains to indicate the selected energy level.

If additional countershocks are necessary, readjust the energy level as necessary, press the **Sync On/Off** softkey, followed by the **Sync** softkey (if your unit supports Remote Sync), and repeat. Note that *SYNC XXXJ SEL* must be displayed prior to pressing the **CHARGE** button.

If the **ANALYZE** button is pressed while the unit is in Sync mode, the unit displays the *REMOVE SYNC* message and does not allow ECG rhythm analysis until the unit is taken out of Sync mode.

Remote Synchronized Cardioversion Procedure

The R Series may be configured to receive defibrillation synchronization pulses from a remote ECG monitoring device. See the *R Series Configuration Manual*. Be sure that the remote device is connected to the Sync In/Marker Out connector on the R Series unit. The remote device must have a Sync out connector and a cable must be provided to connect the two devices. Ensure the remote device conforms with the Sync In/Marker Out specifications (described in Appendix A, “Defibrillator Specifications”).

WARNING! A lethal arrhythmia may be induced through improper synchronization. Qualified personnel within the hospital should verify synchronization delay for the entire remote

monitor and defibrillator system prior to clinical use. Synchronization delay for the system as a whole must not exceed 60 msec.

Determine the Patient's Condition and Provide Care Following Local Medical Protocols

Prepare Patient

Prepare the patient as described in “Prepare Patient” on page 6-2.

Follow the instructions provided with the external monitoring device to prepare the patient for ECG monitoring and synchronization with a separate defibrillator.

1 Select ON

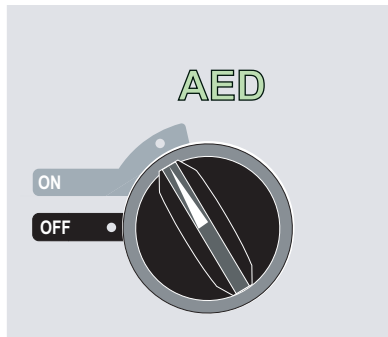

The unit beeps 4 times to indicate that it has passed the power on self test and the green AED label and the ON mode selector light up on the front panel.

Press the **Manual Mode** softkey on the front panel of the unit to enter the Manual mode of operation.

The message *CONFIRM MANUAL MODE* and the **Confirm** softkey will be displayed. Press the **Confirm** softkey to enter the Manual mode of operation. If the **Confirm** softkey is not pressed within 10 seconds, the unit will revert back to AED operation.

Note: If the unit has been configured not to confirm the transition from AED mode to Manual mode, the unit will immediately enter Manual mode.

The control buttons for Manual mode light up on the front panel. Select the desired energy using the up and down arrow keys on the front panel (or sternum paddle if using paddles).

Press Sync On/Off softkey, then press the Remote Sync Softkey

The selected energy level is displayed on the monitor.

The words “REMOTE SYNC” are displayed in place of the ECG trace, and a *REMOTE SYNC XXXJ SEL.* message appears on the display.

The ECG heartbeat indicator will flash with each synchronization pulse received from the remote monitoring device.

Unless otherwise configured, the unit automatically exits Sync mode after each shock, and if the Mode Selector is moved to **OFF**.

Press the **Sync On/Off, Remote Sync** softkey sequence again to reactivate Remote Sync mode. Changing the selected energy levels does not cause the unit to leave Remote Sync mode.

View the ECG trace on the remote device's display. Verify that Sync markers appear with each R-wave. The Sync markers will appear as described in the remote device's user manual.

WARNING! Verify the ECG waveform is stable and that a Sync marker appears only with R-waves. If Sync markers are not present on the remote device display, or do not appear to be nearly simultaneous with each R-wave, do not proceed with synchronized cardioversion.

2 Charge Defibrillator

Press the **CHARGE** button on the front panel or, if using paddles, on the apex paddle handle.

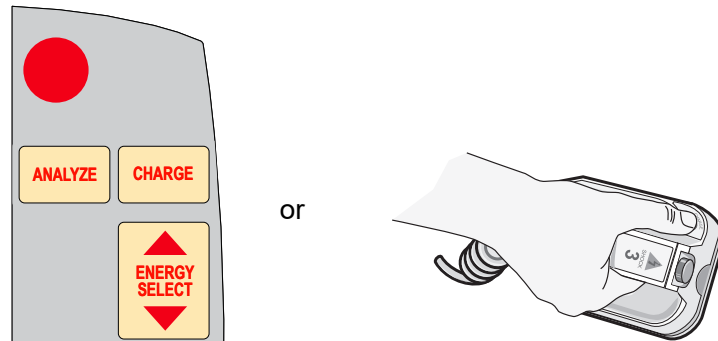

To abort charging and increase or decrease the selected energy after the **CHARGE** button has been pressed, use the **ENERGY SELECT** buttons on either the defibrillator front panel or the sternum paddle. Press the **CHARGE** button again to charge the unit.

After charging the unit to the selected energy, either the front panel **SHOCK** button or, the apex paddle charge indicator illuminates. A distinctive audible tone sounds and the energy ready *REMOTE SYNC XXXJ READY* message is displayed.

The defibrillator is now ready to deliver therapy.

3 Deliver SHOCK

WARNING! Warn all persons in attendance of the patient to **STAND CLEAR** prior to defibrillator discharge.

Verify that no one is in contact with the patient, monitoring cable or leads, bed rails, or any other potential current pathways.

Press and hold the illuminated **SHOCK** button on the front panel, or simultaneously press and hold both paddle **SHOCK** buttons until energy is delivered. The defibrillator will discharge with the next remote synchronization pulse.

Note: If the defibrillator is not discharged within 60 or 120 seconds (user configurable) after reaching the selected energy level, the unit automatically disarms itself. During the ten seconds prior to this internal disarm, the charge ready tone beeps intermittently. The charge ready tone then stops and the defibrillator remains in Remote Sync mode.

Once the energy is delivered, the display simultaneously shows *XXXJ DELIVERED* and *DEFIB XXXJ SEL*. After approximately 5 seconds, the *XXXJ DELIVERED* message disappears and the *DEFIB XXXJ SEL* message remains to indicate the selected energy level.

If additional countershocks are necessary, readjust the energy level as necessary, press the **Sync On/Off**, and then the **Remote Sync** softkeys and repeat. Note that *REMOTE SYNC XXXJ SEL* must be displayed prior to pressing the **CHARGE** button.

If the **ANALYZE** button is pressed while the unit is in Remote Sync mode, the unit displays the *REMOVE SYNC* message and disallows ECG rhythm analysis until the unit is taken out of Sync mode.

Chapter 7

Real CPR Help



Real CPR Help is defibrillation-proof Type BF equipment.

WARNING! The Real CPR Help function is fully functional *only* when using adult CPR electrodes. Do *not* use Adult CPR electrodes with patients under 8 years of age.

WARNING! Use *only* Pediatric CPR electrodes with patients under 8 years of age. The use of Pediatric CPR electrodes enables the R Series unit to display Idle Time and Compression Rate and Depth measurements. Pediatric CPR electrodes do *not* enable Real CPR voice prompts or any visual indication of ineffective CPR.

When used with OneStep CPR electrodes or OneStep Complete electrodes, the R Series unit can provide rescuers with feedback about the quality of CPR they are delivering to their patients. The way in which feedback is provided varies with respect to the operational mode and user configuration, but is derived from compression rate and depth measurements.

When applied according to package instructions, ZOLL OneStep CPR and OneStep Complete electrodes provide a chest compression sensor that is located between the rescuer's hands and the patient's lower sternum. This sensor monitors the rate and depth of chest compressions and sends this information to the R Series unit for processing and display.

The R Series defibrillator uses this information to provide feedback to the rescuer in one or more of the following forms:

- Perfusion Performance Indicator (R Series Plus Only)

- CPR Idle Time Display
- CPR Rate Metronome
- Voice prompts
- Chest Compressions Waveform display
- *FULLY RELEASE* display prompt (if configured)

Real CPR Help Field

Whenever OneStep CPR, or OneStep Complete electrodes are connected to the R Series defibrillator, the unit illuminates the Real CPR Help field in the upper center portion of the display. This field includes the indicators described in the next sections.

Perfusion Performance Indicator (R Series Plus/Adult Only)

This feature is only available in R Series Plus models. This diamond shaped figure provides a quick, overall indicator of how well the rescuer's combined rate and depth of chest compressions match the AHA/ERC recommendations for adult CPR.

Before chest compressions begin (and after each shock), the Perfusion Performance Indicator is displayed as a hollow outline. This index starts to fill from the center out as compressions begin, and becomes fully filled when consistent chest compression depth exceeding 1.5, 1.6, or 2 inches (depending on the configuration) and rate exceeding 100 compressions per minute (cpm) are simultaneously achieved. Should the chest compression rate or depth begin to fall below the AHA/ERC recommended levels, the PPI will only partially fill to indicate the need for more vigorous efforts. Following the cessation of compressions, the PPI's fill level gradually decreases until a hollow outline is displayed after a short period of time.

When complete filling of the Perfusion Performance Indicator has not been achieved due to diminished compression rate or depth, and the CPR Dashboard is configured Off, the R Series will display the words RATE and/or DEPTH to assist the rescuer in determining whether chest compression rate or depth should be increased. When an appropriate rate or depth has been achieved, 100 cpm and 1.5, 1.6, or 2 inches, respectively, one or both of these words will disappear from the display.

This feature is unavailable while using Pediatric CPR electrodes.

CPR Idle Time Display

This display indicates the elapsed time in minutes and seconds since the last detected chest compression. When compressions are being delivered, this time display will be blanked. Three seconds following the cessation of compressions, the display will illuminate and show the elapsed time since the last detected compression. If no compressions have been delivered for more than 20 minutes, dashes (---) will be displayed in this time field.

CPR Rate and Depth Display

If the CPR Dashboard is configured On and the CPR Idle Time is not displayed, the Rate and Depth values are displayed in the default color; the same values are highlighted and change color if they are not within the AHA-recommended range of below 100 or over 120 compressions per minute. This feature is unavailable while using Pediatric CPR electrodes.

Compression Release Bar (R Series Plus/Adult only)

If the CPR Dashboard is configured On, the Compression Release Bar shows the release of the chest compression by the rescuer. When the release of the chest is properly administered (quickly and completely released), the bar will fill all the way to the top.

This feature is unavailable while using Pediatric CPR electrodes.

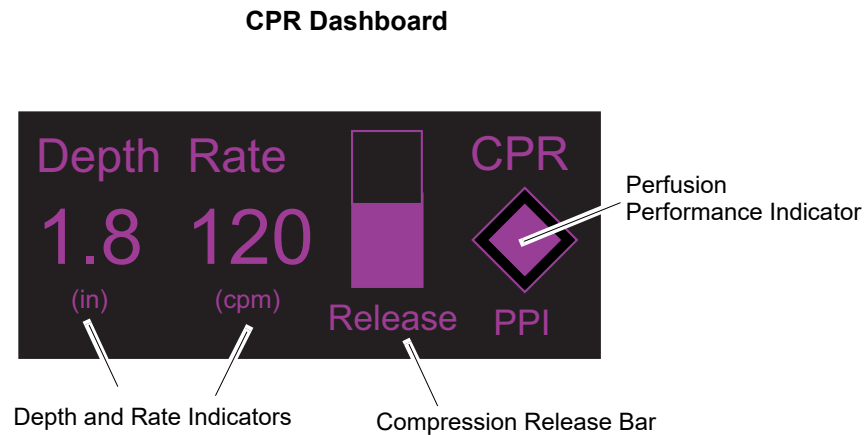

CPR Metronome

The R Series unit includes a CPR metronome feature that can be used to encourage rescuers to perform chest compressions at the AHA/ERC recommended rate of 100 - 120 compressions per minute. This feature can be configured.

When activated, the metronome beeps at the AHA/ERC recommended rate to provide a compression rhythm for rescuers to follow. The metronome is silent when no chest compressions are being detected by CPR-equipped hands-free therapy electrodes.

In AED mode, CPR voice prompts and metronome are always on during the time that clinical protocol instructs the user to perform CPR.

When Manual and Advisory modes are configured to “Yes,” the metronome only beeps when chest compressions are detected and their rate falls below the AHA/ERC recommended levels. When compressions are being performed at 100 compressions per minute or higher, the metronome is silent. Should the detected compression rate fall below this level, the metronome will begin beeping until recommended compression rates are consistently achieved over several compression cycles. The metronome stops beeping approximately 2 seconds after the last chest compression is detected.

When Manual and Advisory modes are configured to “Continuous,” the metronome beeps as long as compressions are detected, even when they are being performed at 100 compressions per minute or higher. The metronome stops beeping approximately 2 seconds after the last chest compression is detected.

Note: Metronome beeps are not provided when the R Series unit detects an AutoPulse[®] in use on the patient.

Fully Release prompt

The R Series unit can be configured to display the text prompt *FULLY RELEASE*, which reminds rescuers to lift (fully release) their hands from the patient's chest during compressions to allow full recoil.

This feature is unavailable while using Pediatric CPR electrodes.

By default, the *FULLY RELEASE* text prompt is not enabled.

CPR Voice Prompts (R Series Plus/Adult only)

The R Series can be configured to issue voice prompts related to the depth of chest compressions as feedback to rescuers performing CPR. Two voice prompts are available for this purpose:

- Push Harder
- Good Compressions

When chest compressions are detected but their depth is consistently less than 1.5, 1.6 or 2 inches (3.8, 4, or 5 cm), depending on the configuration, the defibrillator will periodically issue the prompt “Push Harder” every 15 seconds. If the rescuer responds by increasing compression depth to more than 1.5, 1.6, or 2 inches (3.8, 4, or 5 cm), depending on the configuration, on a consistent basis, the unit will issue a “Good Compressions” prompt.

See the *R Series Configuration Guide* for information on enabling/disabling CPR voice prompts.

CPR Voice prompts are unavailable while using Pediatric CPR electrodes.

Chest Compressions Bar Graph (Manual Mode Only)

The R Series unit can display a CPR compression bar graph computed from the CPR sensor signals. This bar graph, representing depth of compression, is presented on a displacement scale with a reference marker at 1.5, 1.6, or 2.0 inches, depending on the configuration. When the full width of the trace is visible, the unit displays a minimum of 12 seconds of compression data.

Displaying the CPR Bar Graph (Manual Mode Only)

To display the CPR displacement bar graph in the Trace 2 or 3 position:

1. Press the **Options** softkey, then press **Traces**.
2. Press either the **Trace 2** or **Trace 3** softkey.
3. Press **CPR**.

Note: The **CPR** softkey appears only when OneStep CPR or OneStep Complete electrodes are in use.

Chapter 8

See-Thru CPR (R Series Plus Only)

The See-Thru CPR feature is only available in R Series Plus models.

WARNING! The See-Thru CPR filter works only when the R Series defibrillator is monitoring CPR in Manual mode.

The See-Thru CPR filter stops if:

- The unit is in pace mode.
- Patient impedance is invalid.
- OneStep CPR electrodes or OneStep Complete electrodes are no longer detected.

The See-Thru CPR filter will not remove all CPR artifact. Always stop CPR to verify the patient's ECG rhythm before making treatment decisions.

The See-Thru CPR filter does not operate during ECG rhythm analysis. Always stop chest compressions during ECG rhythm analysis to avoid incorrect results caused by the presence of CPR artifact.

Diagnostic bandwidth is never applied to the See-Thru CPR waveform.

See-Thru CPR enables the rescuer to see a close approximation of the patient's underlying ECG rhythm while performing CPR. See-Thru CPR is available if the R Series is monitoring CPR.

Chest compressions introduce *CPR artifact* into the ECG signal. See-Thru CPR uses a filter that relies on the correlation between CPR compressions, as detected by the ZOLL Onestep CPR or OneStep Complete electrodes, and the CPR artifact to remove much, but not all, of the artifact from the ECG signal. Under some conditions, residual noise after filtering can obscure the ECG rhythm, requiring the rescuer to stop CPR to assess the ECG. For example, in the case

of asystole or low amplitude PEA, the residual artifact seen after filtering may look like fine ventricular fibrillation.

Because the filtered ECG signal may contain residual chest compression and/or filtering artifacts, *a rescuer should always follow the standard procedure of stopping CPR to assess the patient's ECG rhythm before determining treatment.*

Using See-Thru CPR (R Series Plus Only)

To use See-Thru CPR

- The R Series unit must be monitoring CPR.
- OneStep CPR or OneStep Complete electrodes must be attached to the unit.

When chest compressions begin, the R Series unit *automatically* starts filtering the CPR artifact after detecting the first 3 to 6 compressions.

The filtered ECG, with the label “FIL,” may be displayed on the second or third trace (by selecting FILT ECG in the Trace2 or Trace3 menu). See-Thru CPR filtering continues as long as the OneStep CPR or OneStep Complete electrodes detect compressions and patient impedance is valid. When no compressions are detected or one of the conditions noted above occurs, See-Thru CPR filtering stops, and unfiltered ECG signals are displayed. When compressions resume, filtering automatically restarts after 3 to 6 chest compressions.

Note: There is a delay of approximately 1/16 second between the See-Thru CPR waveform and the Trace 1 ECG waveform.

If configured to display the CPR Dashboard, the R Series unit can also be configured to display the filtered ECG in Trace1. When the unit is configured to display the filtered ECG in Trace1, the softkey **Disable Filt ECG** appears, which you can press to disable display of the filtered ECG in Trace1 and replace it with the unfiltered ECG. When the unit displays the unfiltered ECG in Trace1, the softkey **Enable Filt ECG** appears, which can redisplay the filtered ECG in Trace1.

Examples

The following examples show the effects of See-Thru CPR filtering on ECG signals contaminated with CPR artifacts.

Each example includes:

- ECG signal with CPR artifact.
- ECG signal after the See-Thru CPR filter has removed CPR artifact.
- Indication of the period during which See-Thru CPR is active.
- CPR signal to show when CPR activity occurred.

The following figure shows a patient in Fine VF. It is difficult for a rescuer to discern this rhythm during CPR compressions. When the CPR filter turns on, the Fine VF rhythm becomes more obvious.

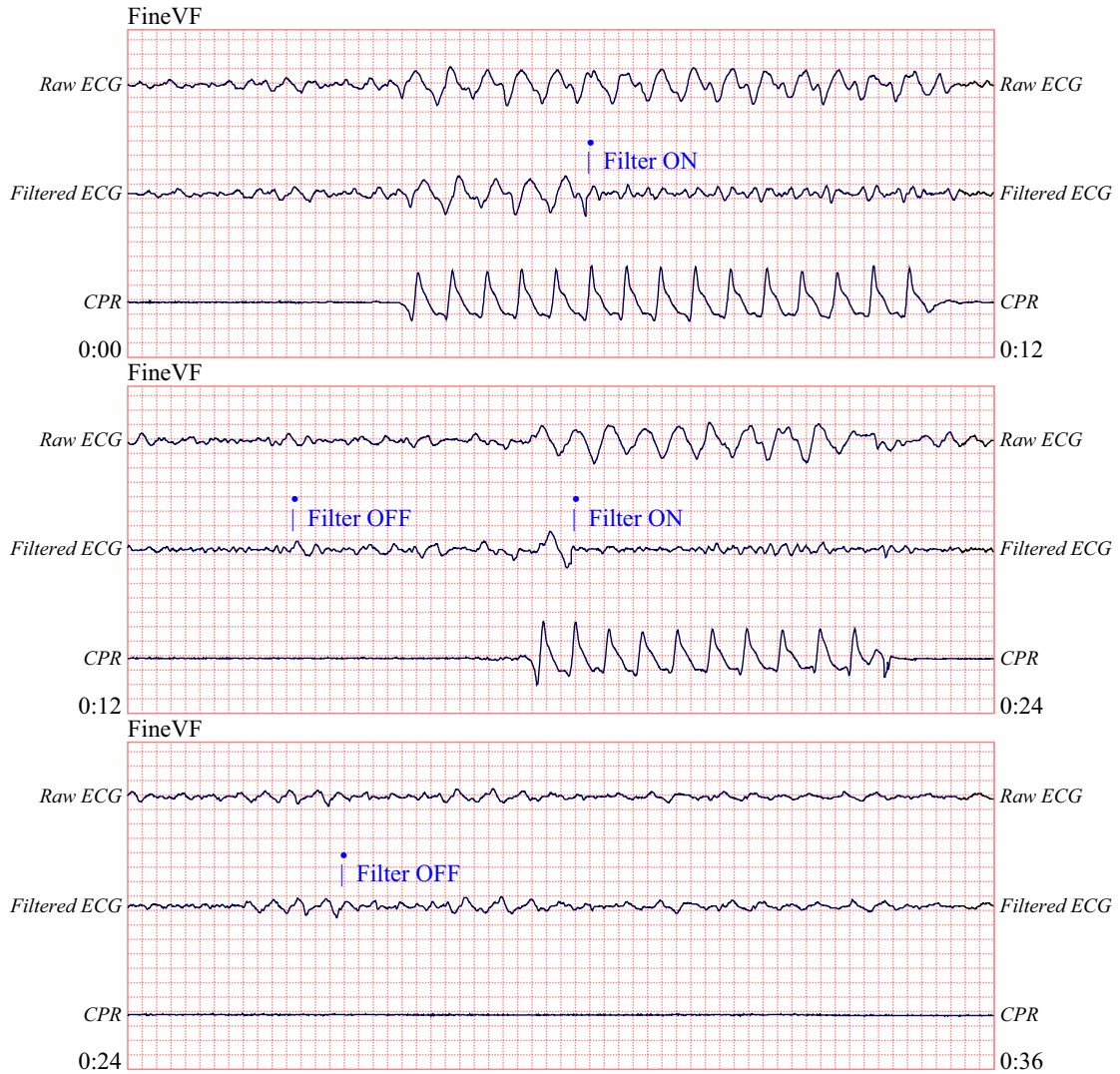

12.5 mm/sec, 5 mm/mV

The following figure shows a patient in VF, which, during compressions, is slightly more difficult to discern. When viewing this ECG, it is possible to view the underlying rhythm as the filter is able to reject all of the CPR artifact.

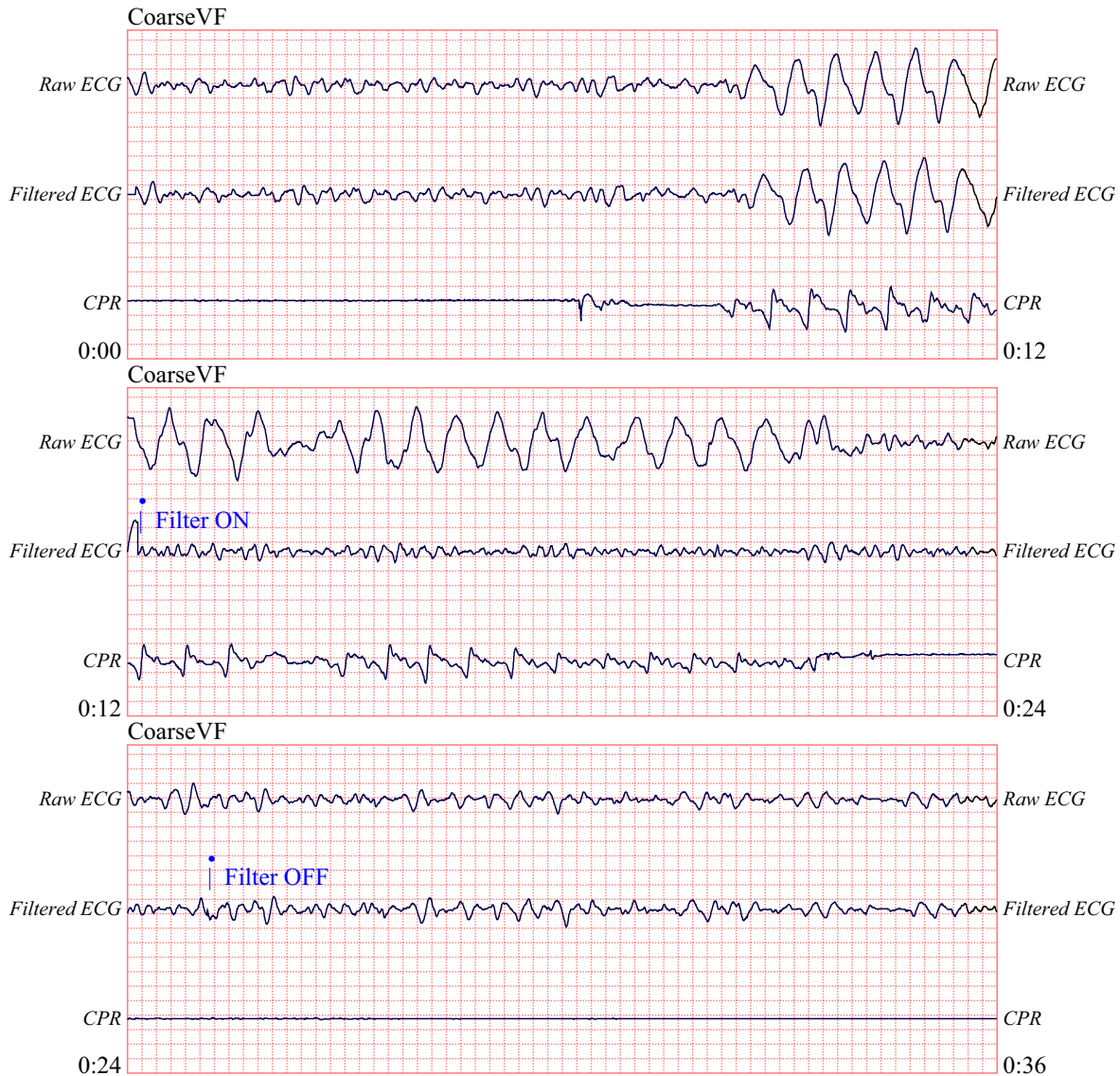

12.5 mm/sec, 5 mm/mV

The following figure shows a patient in PEA, which could easily be mistaken for Fine VF because enough of the compression artifact leaks through to distort this signal. When the CPR filter turns on, the PEA is still not obvious because of the left over ripples from the CPR signal. About 14 seconds into this chart, the rhythm changes to asystole, which could easily be mistaken for coarse VF. When the CPR filter turns on, the CPR compression ripples are still obvious, making the rhythm look like Fine VF.

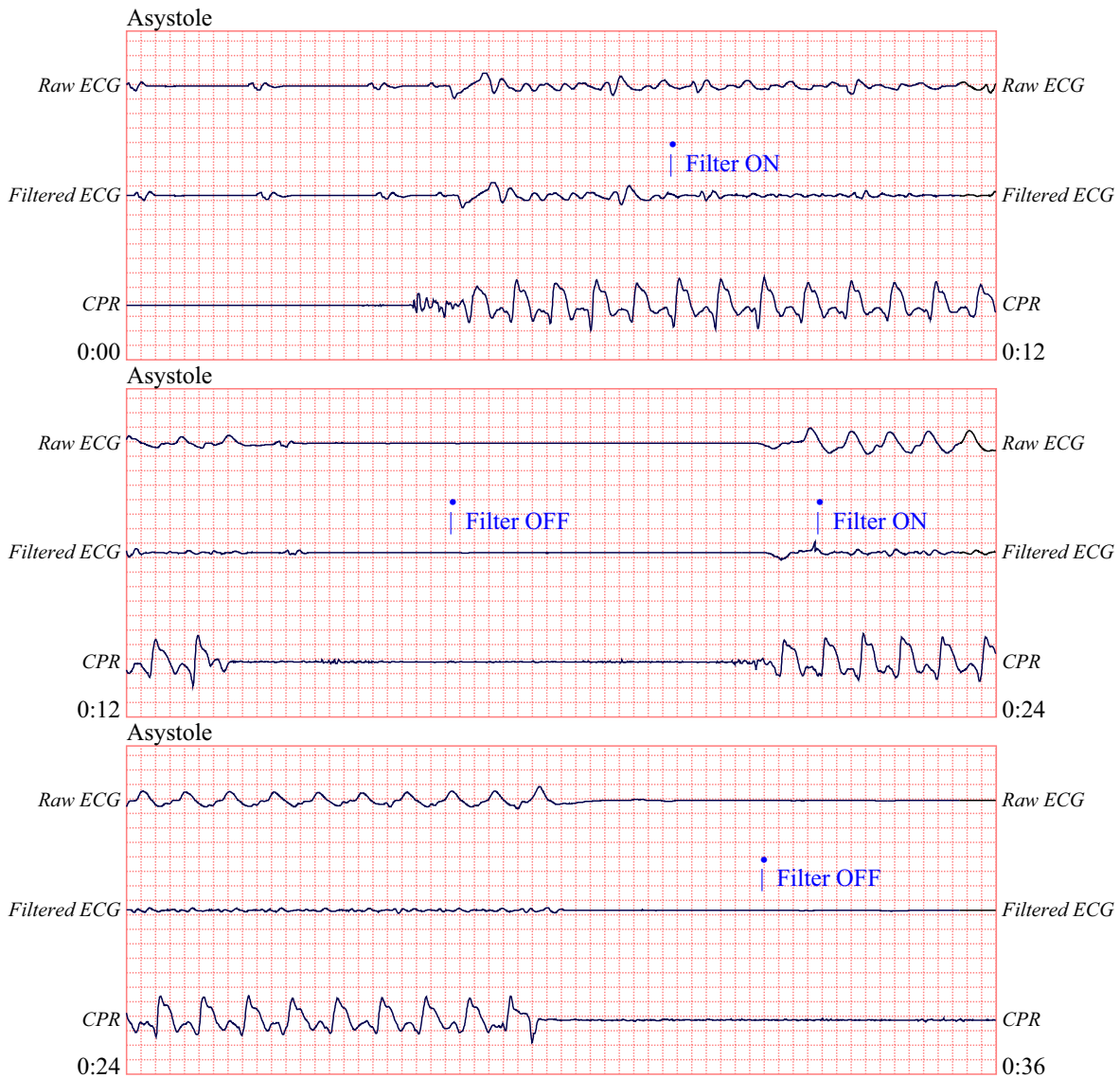

12.5 mm/sec, 5 mm/mV

The following figure shows a patient with an organized rhythm where See-Thru CPR effectively filters out artifact created by CPR.

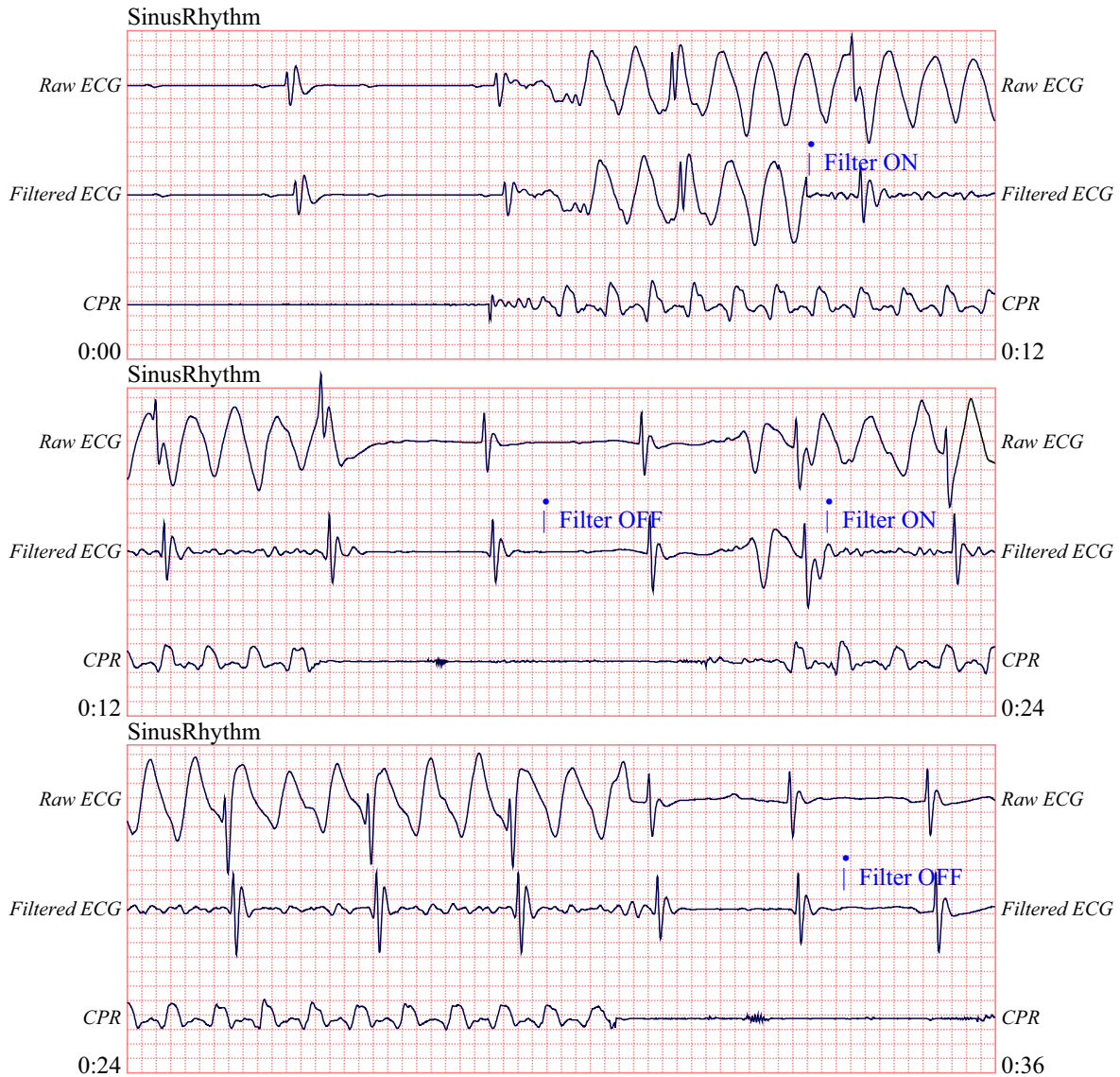

12.5 mm/sec, 5 mm/mV

Chapter 9

Noninvasive Temporary Pacing (Optional)

Note: This is an optional feature and is only available in Manual mode.



When ZOLL hands-free therapy electrodes are used, the patient connection is considered to be defibrillation-protected Type BF.



ECG leads are a defibrillation-protected Type CF patient connection.

WARNING! To avoid risk of electrical shock, do not touch the gelled area of the hands-free therapy electrodes while pacing.

Therapy electrodes should be replaced periodically. Consult electrode directions for specific recommendations.

Prolonged pacing (in excess of 30 minutes), particularly in neonates or adults with severely restricted blood flow, may cause burns. Periodic inspection of the underlying skin is recommended.

If the unit was NOT turned off and less than 10 minutes have elapsed since the pacing mode was last used, reactivating the pacer mode causes pacing to resume immediately at the previously selected mA and ppm settings.

Noninvasive Temporary Pacing

R Series defibrillators with the pacer option contain a VVI demand pacemaker – a safe and effective design for Noninvasive Temporary Pacemakers.

Proper demand pacing requires a reliable, high quality surface ECG signal. For best results:

- Apply both standard ECG monitoring electrodes and hands-free pacing therapy electrodes (such as, OneStep electrodes or Stat-padz) to the patient,
or
- Use OneStep Pacing electrodes, or OneStep Complete electrodes. These hands-free therapy pads include both ECG monitoring and pacing/defibrillation electrodes in a single pad assembly. They provide reliable ECG monitoring without the need to use separate ECG leads. With these electrodes you must also use the OneStep Pacing cable.

Determine Patient Condition and Provide Care Following Local Medical Protocols

Prepare the Patient

Remove all clothing covering the patient's chest. Dry chest if necessary. If the patient has excessive chest hair, clip it to ensure proper adhesion of the electrodes.

1 Apply ECG Electrodes/Hands-Free Therapy Electrodes

The R Series supports two electrode configurations for pacing:

- **OneStep Pacing Configuration**

Simultaneous ECG monitoring and pacing can be performed with a single set of therapy electrodes when using OneStep Pacing electrodes or OneStep Complete electrodes along with a OneStep Pacing cable. The OneStep Pacing cable must be connected to both the MFC and ECG connectors of the R Series unit. Attach OneStep electrodes according to instructions on the electrode packaging. Then connect the electrodes to the OneStep Pacing cable.

- **Separate ECG Electrodes and Hands-free Therapy Electrodes Configuration**

Apply ECG electrodes, attach lead wires, and connect the ECG cable to the R Series rear panel (see page 10-3 for instructions on attaching ECG electrodes to the patient). Attach hands-free therapy electrodes according to instructions on the electrode packaging. Connect these therapy electrodes to the OneStep cable.

Therapy Electrode Application

WARNING! Poor adherence and/or air under the therapy electrodes can lead to the possibility of arcing and skin burns.

1. Apply one edge of the pad securely to the patient.
2. Roll the pad smoothly from the applied edge to the other, being careful not to trap any air pockets between the gel and skin.

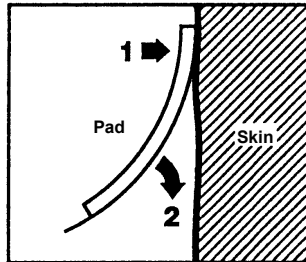

3. Ensure that hands-free therapy electrodes are making good contact with the patient's skin and are not covering any part of any other ECG electrodes.
4. If using OneStep Pacing electrodes or OneStep Complete electrodes, select ECG lead P1, P2, or P3; otherwise, select an appropriate ECG lead. Adjust ECG size for a clean, well-defined ECG signal.
5. Verify proper R-wave detection. The heart-shaped symbol flashes with each R-wave when proper detection is taking place. Adjust ECG size for a clean, well-defined ECG signal.

Note: When the OneStep Pacing electrode configuration is used and the unit is switched to **PACER** mode, P3 is automatically selected as the ECG source. When separate ECG electrodes and hands-free therapy electrodes are used, Lead II is automatically selected as the ECG source.

While ECG signals acquired from P1, P2 or P3 are appropriate for ECG rhythm assessment and determining electrical capture during pacing, they should not be used for diagnostic purposes. Conventional ECG electrodes and cable should be used for this purpose.

1 Select ON

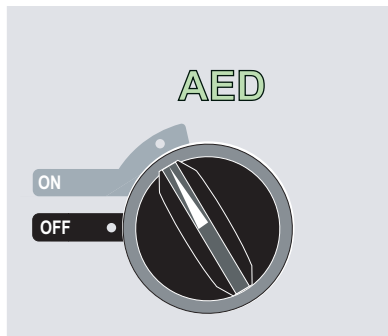

The unit beeps 4 times to indicate that it has passed the power on self test, and the green AED label and the ON mode selector light up on the front panel.

Press the **Manual Mode** softkey on the front panel of the unit to enter the Manual mode of operation.

The message *CONFIRM MANUAL MODE* and the **Confirm** softkey will be displayed. Press the **Confirm** softkey to enter the Manual mode of operation. If the **Confirm** softkey is not pressed within 10 seconds, the unit will revert back to semiautomatic operation.

Note: If the unit has been configured not to confirm the transition from AED mode to Manual mode, the unit will immediately enter Manual mode.

The control buttons for Manual mode light up on the front panel.

2 Turn Mode Selector to PACER

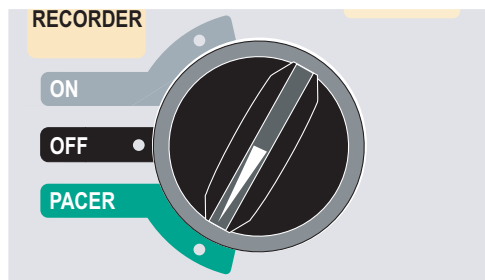

The pacer door drops open and the knobs are displayed.

Set the Pacer Output to 0 mA

If the unit has just been turned on, the **PACER OUTPUT** is automatically set to 0 mA.

3 Set Pacer Rate

Set the **PACER RATE** to a value 10-20 ppm higher than the patient's intrinsic heart rate. If no intrinsic rate exists, use 100 ppm.

The pacer rate increments or decrements by a value of 2 ppm on the display when the knob is turned.

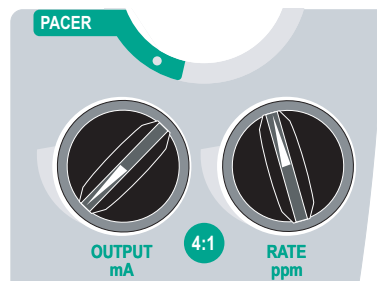

Observe the pacing stimulus marker on the display or stripchart () and verify that it is well-positioned in diastole.

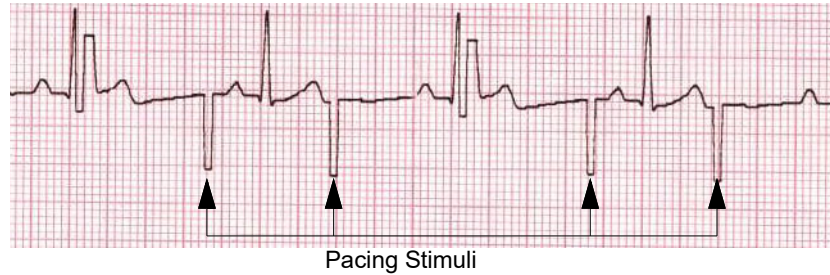

4 Set Pacer Output

Increase **PACER OUTPUT** until stimulation is effective (capture); the output mA value is displayed. The pacer output increments and decrements by a value of 2 mA on the display when the knob is turned.

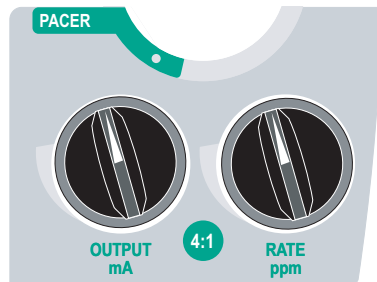

Note: When the unit is switched out of PACER mode into Manual mode and then switched back to PACER mode within 10 minutes, the pacer settings remain unchanged.

If the unit is turned off for more than 10 seconds, the pacer's power up default settings are restored.

5 Determine Capture

It is important to recognize when pacing stimulation has produced a ventricular response (capture). Determination of capture must be assessed both electrically and mechanically in order to ensure appropriate circulatory support of the patient.

Electrical capture is determined by the presence of a widened QRS complex, the loss of any underlying intrinsic rhythm, and the appearance of an extended, and sometimes enlarged, T-wave.

Ventricular response is normally characterized by suppression of the intrinsic QRS complex.

WARNING! Determination of electrical capture should only be performed by viewing the ECG trace on the R Series display with its ECG connection directly attached to the patient. Use of other ECG monitoring devices might provide misleading information due to the presence of pacer artifacts.

Mechanical capture is assessed by palpation of the peripheral pulse.

To avoid mistaking muscular response to pacing stimuli for arterial pulsations, use **ONLY** the following locations for palpating pulse during pacing:

- femoral artery
- right brachial or radial artery

Effective pacing

The following ECG traces illustrate typical examples of effective pacing.

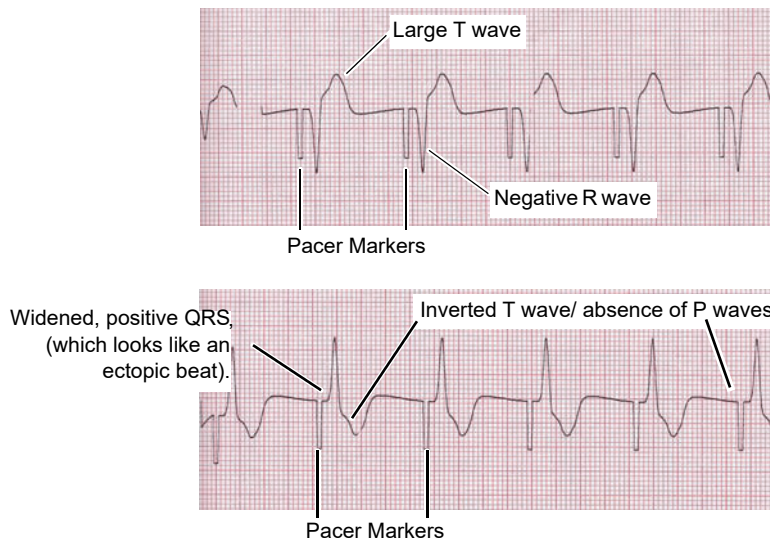

Changing ECG leads and size can sometimes be helpful in determining capture.

Note: The shape and size of the paced ECG waveforms can vary depending on the ECG lead configuration chosen; variation from patient to patient can be expected.

6 Determine Optimum Threshold

The ideal pacer current is the lowest value that maintains capture — usually about 10% above threshold. Typical threshold currents range from 40 to 80 mA. Location of the hands-free therapy or OneStep therapy electrodes affects the current required to obtain ventricular capture. Typically the lowest threshold is obtained when the position of the electrodes provides the most direct current pathway through the heart while avoiding large chest muscles. Lower stimulation currents produce less skeletal muscle contraction and are better tolerated.

4:1 Mode

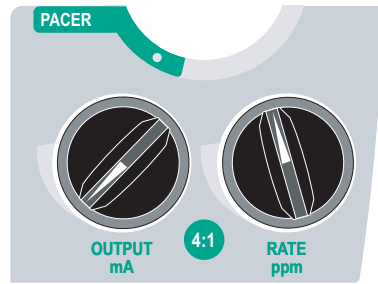

Pressing and holding the 4:1 button temporarily withholds pacing stimuli, thereby allowing you to observe the patient's underlying ECG rhythm and morphology.

When depressed, this button causes pacing stimuli to be delivered at $\frac{1}{4}$ of the indicated ppm setting.

Pace Fault

If the unit is attempting to deliver pacing therapy and one of the following conditions occur, the messages *CHECK PADS* and *POOR PAD CONTACT* are alternately displayed on the screen and an audible alarm sounds:

- The OneStep cable is not connected to the device.
- The cable is defective.
- Therapy pads are not connected to the OneStep cable.
- The therapy pads are not making good skin contact.

The alarm will continue to sound until proper connections between the patient and pacer are achieved and the leftmost softkey (**Clear Pace Alarm**) is pressed.

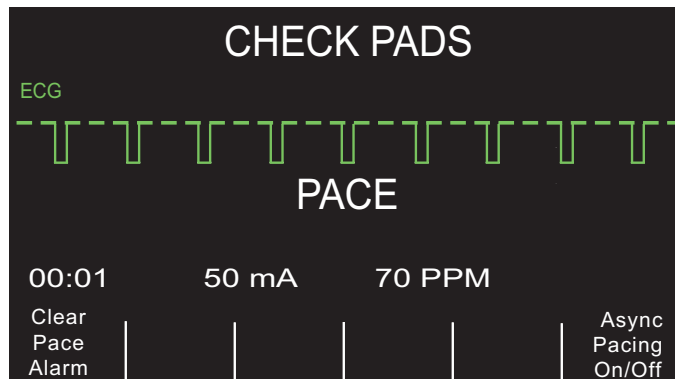

Special Pacing Applications

Noninvasive Temporary Pacing can be performed in the Cardiac Catheterization Lab either for emergency pacing or standby pacing. For pacing in X-ray and fluoroscopic applications, ZOLL Pro-padz[®] radiolucent hands-free therapy electrodes may be used.

Noninvasive Temporary Pacing can be performed in the Operating Room using ZOLL Pro-padz sterile hands-free therapy electrodes.

Caution Under certain conditions, it might not be possible to properly monitor or pace while electro-surgical apparatus is operating. Observe the device carefully for evidence of proper operation.

Standby Pacing

For certain patients at risk of developing symptomatic bradycardia, it may be advisable to use the unit in standby mode. When used in standby mode, the unit automatically provides pacing stimuli whenever the patient's heart rate drops below the pacer rate setting. Patient's ECG must be monitored using one of the two electrode configurations described on page 8-2. To use the device in standby mode:

1. Establish effective pacing (see instructions on previous pages). Note the mA output at capture and run an ECG stripchart to document ECG morphology during capture.
2. Set the mA output 10% higher than the minimum mA output necessary to effect consistent ventricular capture.
3. Turn the pacing rate (ppm) below the patient's heart rate. This suppresses pacing unless the patient's own rate drops below the pacer rate setting. The pacing rate should be set at a level sufficient to ensure adequate cardiac output.
4. Check the threshold periodically.

Asynchronous (Fixed) Pacing

If ECG electrodes are not available or there is some circumstance that prevents or interferes with the surface ECG, the R Series delivers pacemaker pulses asynchronously.

Asynchronous (fixed) pacing should be performed only in an emergency when no alternative is available. To pace asynchronously:

1 Select ON

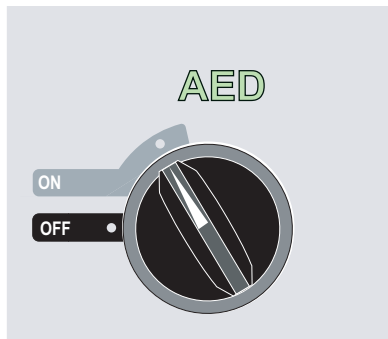

The unit beeps 4 times to indicate that it has passed the power on self test, and the green AED label and the ON mode selector light up on the front panel.

Press the **Manual Mode** softkey on the front panel of the unit to enter the Manual mode of operation.

The message *CONFIRM MANUAL MODE* and the **Confirm** softkey will be displayed. Press the **Confirm** softkey to enter the Manual mode of operation. If the **Confirm** softkey is not pressed within 10 seconds, the unit will revert back to semiautomatic operation.

Note: If the unit has been configured not to confirm the transition from AED mode to Manual mode, the unit will immediately enter Manual mode.

The control buttons for Manual mode light up on the front panel.

2 Turn Mode Selector to PACER

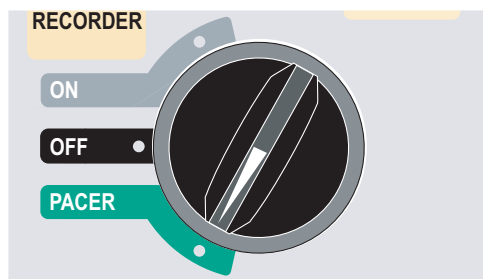

The pacer door drops open and the knobs are displayed.

Press the Async (Fixed) Pacing On/Off softkey

Note: If the pacer output is set to 8 mA or higher, pacing stimuli begin immediately at the set rate.

The display shows “ASYNC PACE” or “FIXED PACE” to indicate that asynchronous pacing has been activated. The annotation “ASYNC PACE” or “FIXED PACE” is also printed on the stripchart when activated by the **RECORDER** button, and printed on the corresponding summary report. To return to demand pacing, press the **Async (Fixed) Pacing On/Off** softkey again. The display returns to “PACE” or “DEMAND PACE.”

Note: You can toggle the screen to read either “ASYNC” or “FIXED.” Refer to the *R Series Configuration Guide* for more information; the default is “ASYNC.”

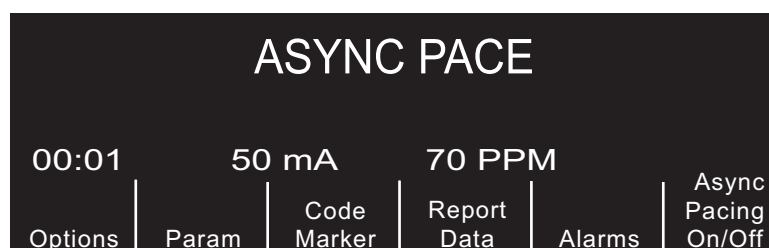

Pace stimuli are also delivered asynchronously whenever there is an *ECG LEAD OFF* condition. Due to the lead off condition, no ECG waveforms will be displayed when pacing by this method. Use other means to determine capture such as checking the patient’s pulse.

When asynchronously pacing with an *ECG LEAD OFF* condition, the rate and mA should be set at the known capture level or high enough (100mA) to presume capture.

Pediatric Pacing

Noninvasive pacing of pediatric patients is performed in an identical manner to adult pacing. Smaller size pediatric therapy electrodes are available for patients weighing less than 55 lbs/25 kg. Continuous pacing of neonates can cause skin burns. If it is necessary to pace for more than 30 minutes, periodic inspection of the underlying skin is strongly advised. Carefully follow all instructions on electrode packaging.

Chapter 10

ECG Monitoring

Note: This option is only available in Manual mode.



ECG leads are a defibrillation-protected Type CF patient connection.

The R Series products can be used for either short- or long-term ECG monitoring.

R Series products have built-in circuitry to prevent damage to their ECG monitoring circuits during defibrillation. Monitoring electrodes, however, can become polarized during defibrillator discharge, causing the ECG trace to briefly disappear from the screen. High-quality silver/silver chloride (Ag/AgCl) electrodes minimize this effect. Circuitry in the unit returns the ECG trace to the display within a few seconds.

You can monitor a patient's ECG using an ECG patient cable, hands-free therapy electrodes, or through standard defibrillation paddles.

During ECG monitoring, the R Series displays the following information:

- Five seconds of ECG waveforms
- Heart Rate
- Heartbeat indicator
- ECG source lead (I, II, III, aVR, aVL, aVF, or V with ECG cable; PADS, or PADDLES)
- ECG size relative scale factor - x0.5, x1, x1.5, x2, x3
- Alarm indicator

Whenever more than one waveform is displayed, the selected ECG lead appears as the uppermost trace (unless the unit is configured for Filtered ECG).

Caution ECG electrodes embedded in OneStep Pacing and Complete resuscitation pads produce non-standard ECG monitoring lead vectors, designated P1, P2 and P3. While ECG signals acquired from these leads are appropriate for ECG rhythm assessment and determining electrical capture during pacing, they should not be used for ECG morphological evaluations. Attach conventional ECG electrodes for diagnostic purposes.

Note: Under certain clinical circumstances, the R Series heart rate counting system may respond to narrow, high-amplitude spikes in the ECG signal (e.g., 10 msec duration, 1 mV peak-to-peak amplitude) leading to miscounting of the patient's heart rate. Do not rely on heart rate meters if the ECG waveform contains narrow, high-amplitude spikes. If there is a question about the accuracy of heart rate counting, verify the patient's heart rate by taking his/her pulse.

Preparations

Proper application and placement of electrodes is essential for high quality ECG monitoring. Good contact between the electrode and skin minimizes motion artifact and signal interference. Remove all clothing covering the patient's chest. Dry chest if necessary. If the patient has excessive chest hair, clip or shave it to ensure proper adhesion of the electrodes.

Electrode Placement

Depending upon local usage, the ECG leads are marked either RA, LA, LL, RL, and V or R, L, F, N and C. The following table shows the markings and color codes for the different lead sets.

IEC Color Coding	AHA Color Coding	Placement of Electrodes
R/Red Electrode	RA/White Electrode	Place near patient's right mid-clavicular line, directly below clavicle.
L/Yellow Electrode	LA/Black Electrode	Place near patient's left mid-clavicular line, directly below clavicle.
F/Green Electrode	LL/Red Electrode	Place between 6th and 7th intercostal space on patient's left mid-clavicular line.
N/Black*	RL/Green* Electrode	Place between 6th and 7th intercostal space on patient's right mid-clavicular line.
C/White* Electrode	V/Brown* Electrode	Single movable chest electrode.

* Not used for 3-lead monitoring

3-lead configuration

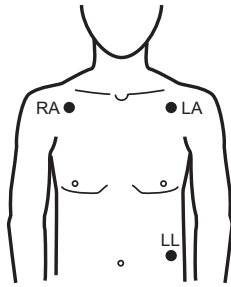

5-lead wire configuration

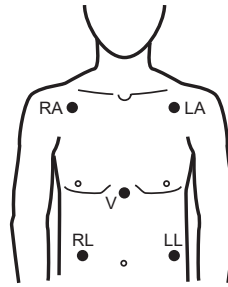

3-lead set

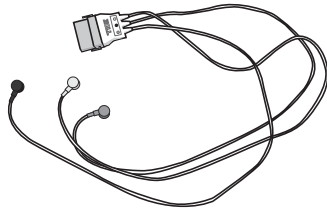

3-lead cable

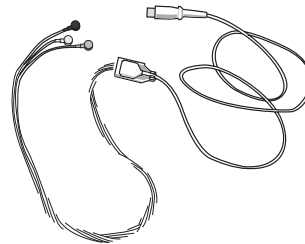

5-lead cable

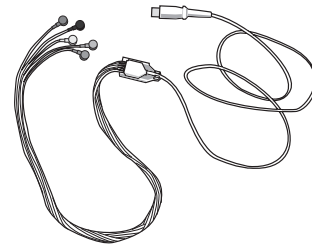

Note: Lead sets and lead cables are different accessories and are not interchangeable. For 5-lead monitoring, use a 5-lead cable.

Note: 3-lead cables are available with and without Electro Surgical Unit noise suppression. If the R Series unit is being used in the presence of an ESU, ablation device, or any other high electromagnetic noise emitting source, ZOLL recommends using the R Series 3-Lead ECG Cable, ESU Filtered (**REF** 9500-000693) specifically designed to limit ESU artifact when monitoring heart rates.

Monitoring Electrodes Attachment

Attach snap-on leads to electrodes and check for good contact between the electrode and the lead termination.

If you are using a 3-lead set, connect the end of the 3-lead set to a OneStep Pacing cable.

Note: The 3-lead set is a standard option with R Series Plus models.

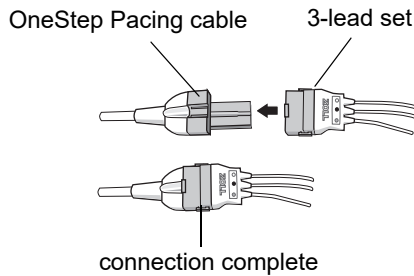

Peel the protective backing from the ECG electrode. Be careful to keep adhesive surface free of electrolyte gel.

Caution Only use electrodes that are well within the expiration date indicated on the package.

Apply the ECG electrodes firmly to the patient's skin, pressing around the entire perimeter of the electrodes.

Plug the patient cable connector into the black ECG input connector (located on the rear panel of the instrument).

Note: If you are using a 3-lead set that is connected to a OneStep Pacing cable, plug the red connector into the red OneStep cable input connector on the device, and plug the connector (that is black inside) into the black ECG input connector on the device.

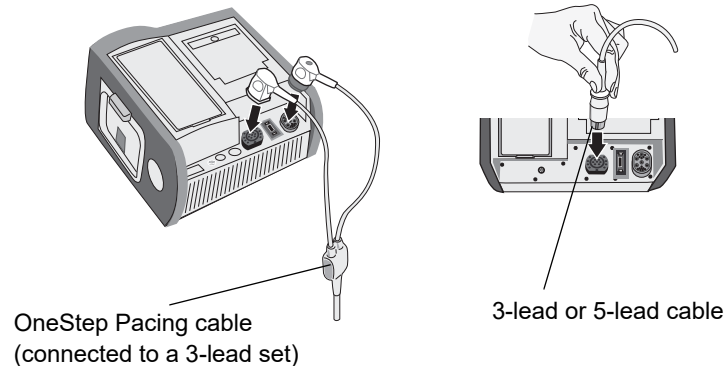

Caution To avoid electrosurgery burns at monitoring sites, ensure proper connection of the electrosurgery return circuit so that the return paths cannot be made through monitoring electrodes or probes.

During electrosurgery, observe the following guidelines to minimize ESU interference and provide maximum user and patient safety:

- Keep all patient monitoring cables away from earth ground, ESU knives, and ESU return wires.
- Use electrosurgical grounding pads with the largest practical contact area.

Always assure proper application of the electrosurgical return electrode to the patient.

Monitoring the Patient's ECG

Set the Controls

Set the Mode Selector to ON. The unit beeps 4 times to indicate that it has passed the power on self test, and the green AED label and the ON switch light up on the front panel.

Press the **Manual Mode** softkey on the front panel of the unit to enter the Manual mode of operation.

The message *CONFIRM MANUAL MODE* and the **Confirm** softkey will be displayed. Press the **Confirm** softkey to enter the Manual mode of operation. If the **Confirm** softkey is not pressed within 10 seconds, the unit will revert back to semiautomatic operation.

Note: If the unit has been configured not to confirm the transition from AED mode to Manual mode, the unit will immediately enter Manual mode.

The control buttons for Manual mode light up on the front panel. Press the **LEAD** button until the desired lead configuration is selected. The selected lead is indicated at upper right of the display.

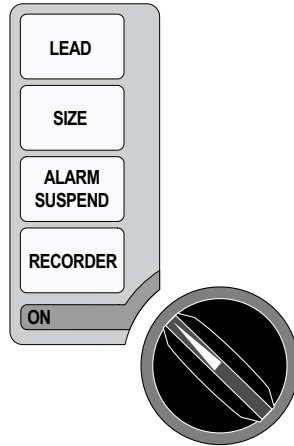

If the unit displays the *ECG LEAD OFF*, *POOR LEAD CONTACT*, or *CHECK PADS* message, inspect the ECG electrodes or therapy electrodes, lead wires, and cables for proper connections.

If heart rate alarms are enabled with paddles selected, the unit displays the messages *SELECT LIMB LEADS* and *VF ALARMS OFF*. If you see these messages, select limb or precordial leads.

If you want to change the size of the displayed ECG waveform, press the **SIZE** button until the desired waveform size is displayed. Options are 0.5, 1, 1.5, 2, and 3 times the normal size.

If you want to shut off the heart rate beeper, press the **Options**, then the **QRS VOL OFF** softkeys. To turn it back on, press the **QRS VOL ON** softkey.

WARNING! Implanted pacemakers may cause the heart rate meter to count pacemaker pulses during incidents of cardiac arrest or other arrhythmias. Pacemaker patients should be carefully observed. Check the patient's pulse; do not rely solely on heart rate meters. Dedicated pacemaker detection circuitry may not detect all implanted pacemaker spikes; patient history and physical exam are important in determining the presence of an implanted pacemaker.

Implanted Pacemakers

The R Series device can be configured to detect pacemaker signals from a patient with an implanted pacemaker and indicate their presence on the display. When pacemaker pulses are detected, the device displays a 5mm, vertical, solid line on the ECG trace.

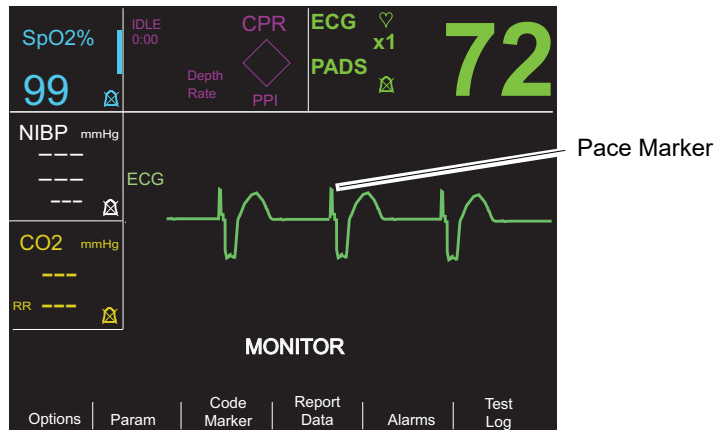

To disable detection of pacemaker spikes:

1. Press the **Param** softkey.
2. Press **ECG**.
3. Press **Disable Pacer Detect**.

The Pacer Off icon () appears in the ECG field to indicate that detection and rejection of implanted pacemaker pulses by the heart rate detector is disabled. Do not disable the implanted pacemaker detector when monitoring patients known or suspected to have an implanted pacer. Disabling pacemaker pulse detection under these conditions can result in erroneously counting pacemaker pulses as R-waves leading to the display of inaccurate heart rates.

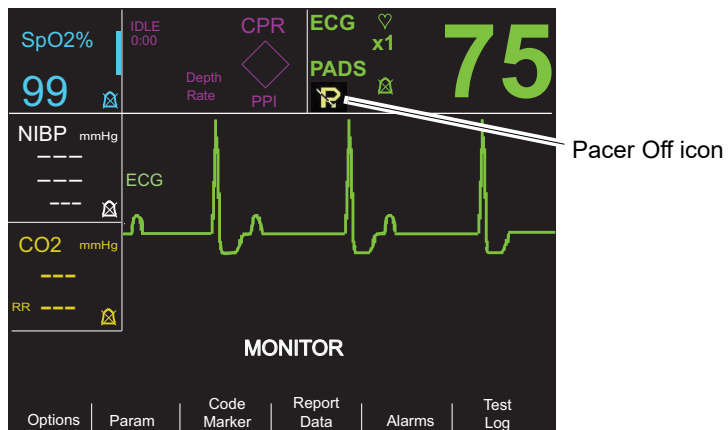

To re-enable detection of pacemaker spikes:

1. Press the **Param** softkey.
2. Press **ECG**.
3. Press **Enable Pacer Detect**.

5-Lead Monitoring

You can perform 5-lead ECG monitoring with the appropriate ECG patient cable. The 5-lead cable allows you to monitor the following ECG leads:

- I, II, III
- aVR, aVL, aVF
- V1

Changing from 3-Lead Monitoring

To change from 3-lead to 5-lead monitoring, simply disconnect the 3-Lead ECG patient cable (or OneStep Pacing cable ECG connector) and connect the 5-lead ECG cable. Refer to the beginning of this section for appropriate preparations (i.e., placing electrodes, attaching electrodes, setting the controls, etc.).

If any ECG lead becomes disconnected during monitoring, an *ECG LEAD OFF* message appears on the display.

Changing from 5-Lead ECG Monitoring

To change from 5-lead monitoring to 3-lead monitoring, you must power off the unit for at least 10 seconds, remove the 5-lead cable, connect the 3-lead cable, then power on the unit again. If you fail to shut the unit off for at least 10 seconds, the unit displays the *ECG LEAD OFF* message after you disconnect the 5-lead wire cable, even if leads from a 3 lead ECG cable are properly attached to the patient.

Simultaneous 3-Lead Printing

The R Series unit can display and print three simultaneous ECG leads when using a 5 lead cable and an ECG lead is selected as the signal source (not PADS or PADDLES).

Note: This feature does not work with a 3 lead cable or in Pacer mode.

To display and print 3 simultaneous leads:

1. Press the **Options** softkey, then press the **Traces** softkey.
2. Press **3 Leads**.

Leads belong to two groups: limb leads (I, II and III) and augmented leads (aVR, aVL, and aVF). The selected lead is always displayed and printed in the Trace 1 uppermost position. The other two leads are displayed in the Trace 2 and 3 positions. For example, if aVL is the selected Trace 1 lead, the Trace 2 and 3 positions display aVR, and aVF respectively.

3 ECG leads will also be printed (when an ECG lead is selected) if the “Print 3 Leads When Leads are Sel.” configuration option is set to YES. Refer to the *R Series Configuration Guide* for instructions.

See-Thru CPR Filter (R Series Plus Only)

The See-Thru CPR feature is only available with R Series Plus models. When OneStep CPR electrodes or OneStep Complete electrodes are in use, the R Series unit allows simultaneous display and printing of the selected ECG lead and the same ECG lead with CPR filtering applied. The CPR filter uses signals from the electrode’s CPR sensor to help reduce artifact in

the ECG signal caused by mechanical compressions of the chest, thereby providing a clearer view of the ECG during periods of CPR. For more detailed information on this feature, see Chapter 8, "See-Thru CPR (R Series Plus Only)".

To apply the See-Thru CPR Filter to the selected ECG lead and display it:

1. Press the **Options** softkey, then press the **Traces** softkey.
2. Press the **Trace 2** or **Trace 3** softkey.
3. Press **Filt ECG**.

If Display Filtered ECG in Trace1 is configured, the unit displays the filtered ECG in Trace1. You can then switch between filtered and unfiltered ECG using the **Enable/Disable Filt ECG** softkey. With the unfiltered ECG displayed in Trace1, the user of the R Series unit can also enable the display of the filtered ECG in Trace2 or Trace3.

Adding Traces to Be Displayed

The screen can display up to three traces simultaneously. The trace for the selected ECG lead always appears in the Trace 1 uppermost position.

If optional physiological monitoring parameters are installed in the unit, the operator can select applicable traces to appear in the second or third position.

To select the display for the second or third trace:

1. Press the **Options** softkey, then press **Traces**.
2. Press **Trace 2** or **Trace 3** to select the position.
3. Press the softkey for the parameter or other waveform to display in the selected position (or **Off** to clear that position).

Note: Trace 3 is not available while the unit is in Pacer mode.

Printing the ECG on a Stripchart

The stripchart recorder documents the ECG trace with a 6 second delay at all times. To start the stripchart recorder, press the **RECORDER** button. The stripchart recorder runs continuously until you press the button again.

Each time the strip chart recorder is started, the time, date, ECG lead, size, and heart rate are printed on the top part of the paper. If the unit is pacing, the output current is also printed.

Note: Check the paper supply at the beginning of each shift and after each use to ensure adequate recording capability. A colored stripe on the paper means that the paper supply is low.

A *CHECK RECORDER* message appears on the display when the stripchart recorder is activated without paper. The stripchart recorder automatically shuts off when there is no paper.

After loading new paper, press the **RECORDER** button to start the strip chart recorder.

Diagnostic Bandwidth

When using an ECG cable for monitoring, you can switch the unit to diagnostic bandwidth (0.05-150 Hz) by pressing and holding the **RECORDER** button depressed. Diagnostic

bandwidth is maintained and printing continues as long as the **RECORDER** button is held down. The unit reverts to standard monitoring bandwidth when you release the **RECORDER** button.

Alarms

Setting Alarm Limits

Unless configured otherwise, heart rate alarms are preset at 30 bpm (bradycardia) and 150 bpm (tachycardia). Refer to the *R Series Configuration Guide* for details on setting power-up alarm limits.

To set alarm parameters:

1. Press the **Alarms** softkey to view the Alarm Set screen and softkeys.

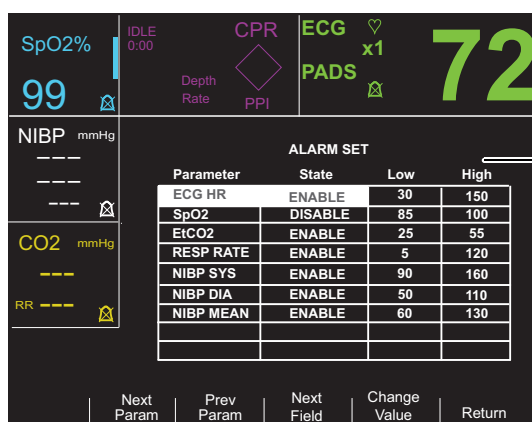

Each setting includes the alarm state (ENABLE, DISABLE, or AUTO) and the low and high limit of the acceptable range of values.

2. Press the **Next Param** or **Prev Param** softkey.

This scrolls the highlighted area among the different available vital signs.

If you want to change the state of the highlighted vital sign:

- a. Press the **Change Value** softkey.
- b. Press the **Inc >** or **Dec <** softkey to change the state value.
- c. Press the **Enter** softkey.

The State field can be set to three possible values, Enable, Disable, or Auto.

- Disable permanently turns off alarm processing for the selected physiological parameter.
- Enable causes alarm processing to operate whenever alarms are activated via the front panel **ALARM** key.
- Selecting AUTO sets the lower and upper alarm limits to 80% and 120% of the patient's currently measured heart rate, if valid measurements are present for the vital sign when the **Enter** softkey is pressed. (Refer to appropriate Operator's Guide parameter insert(s) for percentages associated with other parameters).

3. Press the **Next Field** softkey to move to the Low or High field for the highlighted vital sign; repeat steps 2a through 2c to change the Low or High value.

Note: To recalculate the Low and High limits for any parameter when these limits have previously been set using the AUTO State, follow the procedure above to select AUTO again, and then press the **Enter** softkey. The unit automatically resets the Low and High limits based upon the currently measured value of the selected physiological parameter.

4. Press the **Return** softkey to set all values and return to normal operating mode.

Heart Rate Alarm Limits

The heart rate is displayed in the upper right-hand corner of the screen.

Unless configured otherwise, heart rate alarms are preset at 30 bpm (bradycardia) and 150 bpm (tachycardia). The low heart rate alarm limit range is 20 bpm to 100 bpm.

When the unit is monitoring a patient's heart rate via ECG, the range for the high heart rate alarm limit is 60 to 280 bpm with a default setting of 150 bpm. When the unit is monitoring a patient's pulse rate via pulse oximetry (SpO₂), however, the unit automatically lowers the upper limit for the high heart rate alarm to 235 bpm. The unit restores the original high heart rate alarm limit when ECG monitoring resumes.

Vital Sign Alarms

Each vital sign has associated high and low alarm limits. You can set alarm limits for patient heart rate and other optional monitoring parameters such as pulse oximetry (SpO₂), non-invasive blood pressure (NIBP), or end-tidal carbon dioxide monitoring (EtCO₂), if available.

The R Series unit has three levels of alarms:

- **High Priority** — Reflects physiological parameters that are out of bounds. When these alerts occur, the unit emits an audio tone at 2.86 KHz, highlights the alarming parameter, and flashes the associated alarm bell.
- **Medium Priority** — Reflects equipment- related, user correctable faults such as *LEAD OFF*. The unit emits a two beep audio tone and displays a message for a timed period.
- **Low Priority** — Informational message only; the unit emits a two beep audio tone and displays a message for a timed period.

Suspending and Silencing Alarms

When a high priority alarm occurs, the unit emits a continuous alarm tone, highlights the value of the alarming parameter on the display, and flashes the bell icon associated with that parameter.

You can either suspend the alarm tone for 90 seconds or you can silence the alarm tone.

Suspending Alarm Tones



To suspend an alarm tone for 90 seconds, press and release the **ALARM SUSPEND** button in *less than 1 second*. The alarm tone stops, the unit displays an "X" across the alarm's flashing bell icon, and the value for the alarming parameter remains highlighted. (If you press the **ALARM SUSPEND** button again, alarm processing is reactivated.)

After 90 seconds, if the physiological parameter remains at a value that triggers the alarm, the unit sounds the alarm tone again.



If the alarm condition clears (the physiological parameter returns to a value within range) after you suspend the alarm tone, the unit resets the alarm and displays the bell icon (no flashing, no “X”). The alarm parameter displays normally (no highlighting).

If a second, different alarm occurs after you suspend an alarm tone, you can suspend the alarm tone for that second parameter by pressing and releasing the **ALARM SUSPEND** button again. The unit behaves the same as described above for the first alarm. Suspending a second alarm does not alter the timing or processing of the previously suspended alarm.

Silencing Alarm Tones



To silence the alarm tone, *press and hold down* the **ALARM SUSPEND** button for *between 1 and 3 seconds*. The alarm tone stops, the unit displays the alarm’s bell icon in inverse video with an “X” across it, and the value of the alarm parameter remains highlighted. (If you press the **ALARM SUSPEND** button again, alarm processing is reactivated.)

The alarm tone will not sound again as long as the physiological parameter’s value remains out of range.



If the alarm condition clears (the physiological parameter returns to a value within range) after you silence the alarm tone, the unit resets the alarm and displays the bell icon (no inverse video, no “X”). The alarm parameter value displays normally (no highlighting).

After the unit resets an alarm, should the physiological parameter again go out of range, it will trigger the alarm.

Activating and Deactivating Alarm Processing



To deactivate all alarms on the R Series unit, *press and hold down* the **ALARM SUSPEND** button *for 3 seconds or longer*. The bell icons for all alarms will have an “X” through them to indicate that the alarms are deactivated. Alarm parameter values display normally (no highlighting).

To reactivate the alarms, press and release the **ALARM SUSPEND** button in *less than 1 second*.

Smart Alarms

In Manual mode, ECG/heart rate alarm capabilities are enhanced with the defibrillation advisory feature called Smart Alarms. When alarms are operating, this feature triggers an audible alarm and displays the message *CHECK PATIENT* whenever the unit detects ventricular fibrillation or wide complex ventricular tachycardias. This message appears on the display and the stripchart recorder print out.

If alarms are operating in PACER mode, the unit displays *VF ALARMS OFF*, indicating that the Smart Alarms feature has been disabled.

The Smart Alarms feature is always disabled when augmented leads (aVR, aVL, aVF), V-leads, or PADDLES are selected for ECG monitoring. The messages *VF ALARMS OFF* and *SELECT LIMB LEADS* are alternately displayed when alarms are activated and augmented leads or V-leads are selected. These messages are displayed only the first time you select the augmented or V-leads. They are not redisplayed as you cycle through the lead selection.

Alarm Settings for Unattended Monitoring

Alarms for all monitored parameters should be activated whenever a patient is left unattended. Alarm limits should be intentionally set to levels appropriate for detecting relevant changes in the patient's condition. Leaving alarm settings at their default levels or setting them to the extremes of their ranges may defeat the utility of the alarms even when they are activated.

Chapter 11

Event Records and Reports

Note: This option is only available in Manual mode.

The R Series defibrillator records important event information during operation. You can retrieve this information in various forms:

- **Summary Report** — Summary report allows you to store and later retrieve important ECG and event information. You can print summary report information in various formats. For more information about Summary Report and how to print a report, refer to the Summary Report section below.
- **Full Disclosure Recording** — Full Disclosure waveforms along with event information are stored and may be reviewed using ZOLL RescueNet software. For information about Full Disclosure Recording, refer to “Full Disclosure Recording” on page 11-9.
- **Incident Log** — The Incident log is an abbreviated list of all major events recorded in Summary Report. For more information about the Incident log and how to print it, refer to “Printing an Incident Log” on page 11-9.

Summary Report

The R Series defibrillator automatically records defibrillation and cardioversion events, PACER mode information, heart rate alarms, and segments of ECG when the recorder is activated. Associated event information including device control settings, time, and date are also recorded.

The following events trigger Summary Report to automatically record information:

- Power is turned on.
- Unit is in Manual mode.
- Stripchart recorder is turned on.
- Defibrillator shock is administered.
- Code markers entered.

- ECG rhythm analysis is initiated.
- VF alarm is triggered.
- Parameter alarm is triggered.
- Mode Selector is turned to PACER (after entering Manual mode).

Note: Diagnostic bandwidth recordings are not included in Summary Report.

The unit stores and prints summary information in chronological order. The memory allocated for summary data can hold up to 350 defibrillation or 350 recorder-activated events. All event data remains in memory and is accessible until data is manually erased or until the preconfigured time interval has elapsed. (The time interval is specified in the Set Report Restart Delay parameter; see the *R Series Configuration Manual* for more information). A new patient record is automatically created when the unit has been turned off for a configurable time period of 5 minutes to 72 hours. When all memory for code summary is used, the unit issues the message *MEMORY FULL*.

To continue recording the code event after the memory has been filled or to prepare the unit for a new code, the operator can erase the stored records. (Refer to “Erasing Summary Report and Full Disclosure” on page 11-10.)

Summary Report Formats

This section describes the information included with each type of summary report record.

Each summary report begins with an overview of all events currently stored in memory including:

- Date and time
- Report start time (either when the unit was turned on or, if data was manually erased, when subsequent recording began)
- Time of the last recorded event
- Total number of shocks delivered
- Cumulative pacing time
- Device ID
- System serial number

Space is provided for patient name and comments. On the last event recorded, the unit prints “SUMMARY COMPLETE” on the bottom left of the stripchart.



Figure 11-1. Summary Report

Defibrillation Event Format

The summary report function records 6 seconds of pre-shock and 9 seconds of post-shock patient ECG data. Also recorded are joules selected, joules delivered, Sync if active (includes Sync markers), ECG lead, ECG size, patient current, defib impedance, actual time and date. The date/time printed on the top of the strip corresponds to the ECG data occurring 6 seconds before the event.

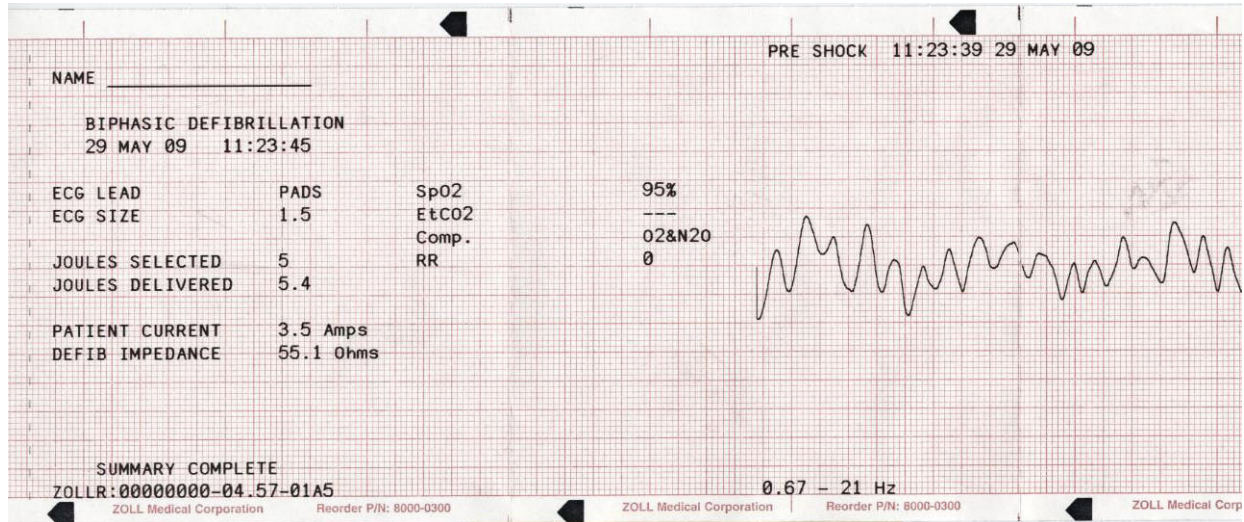

Figure 11-2. Defibrillation Event Format (Pre-Shock)

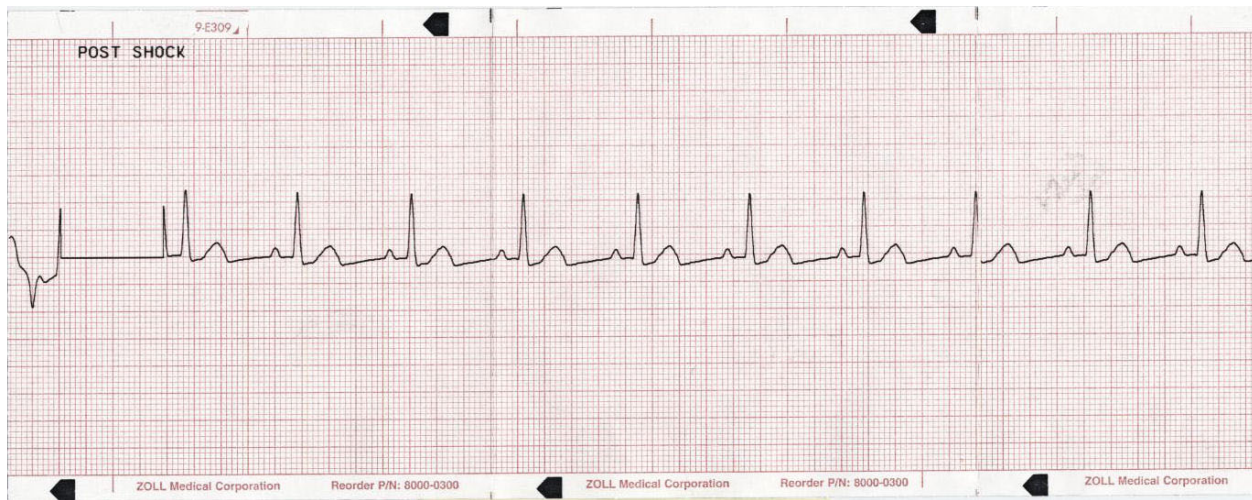

Figure 11-3. Defibrillation Event Format (Post Shock)

Disarm Event Format

The summary report function records 6 seconds of patient ECG data prior to the disarm. Also recorded are Sync if active (includes Sync markers), ECG lead, ECG size, patient current, defib impedance, actual time and date. The date/time printed on the top of the strip corresponds to the ECG data occurring 6 seconds before the event.

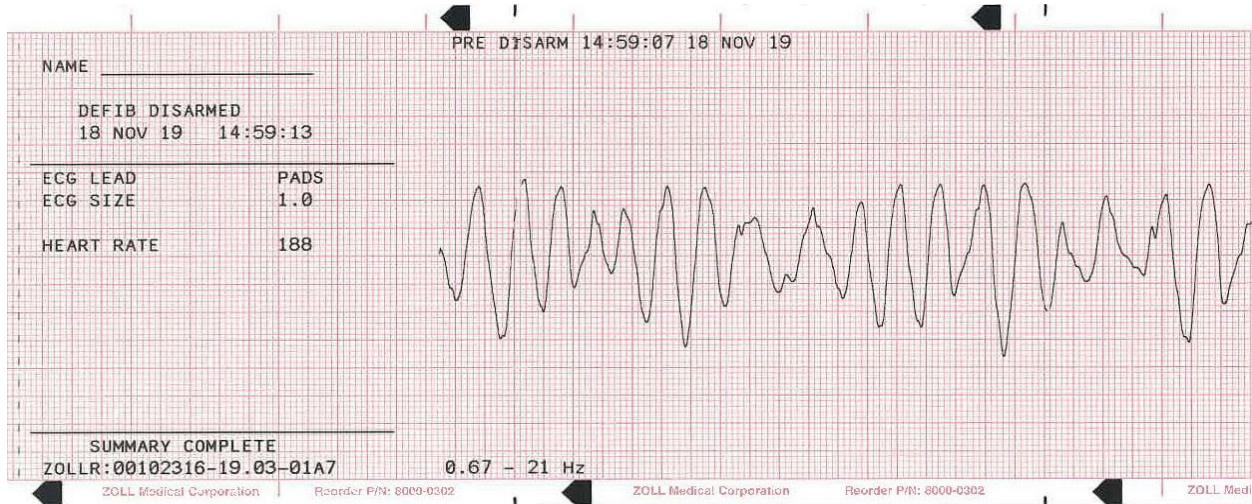

Figure 11-4. Disarm Event Format

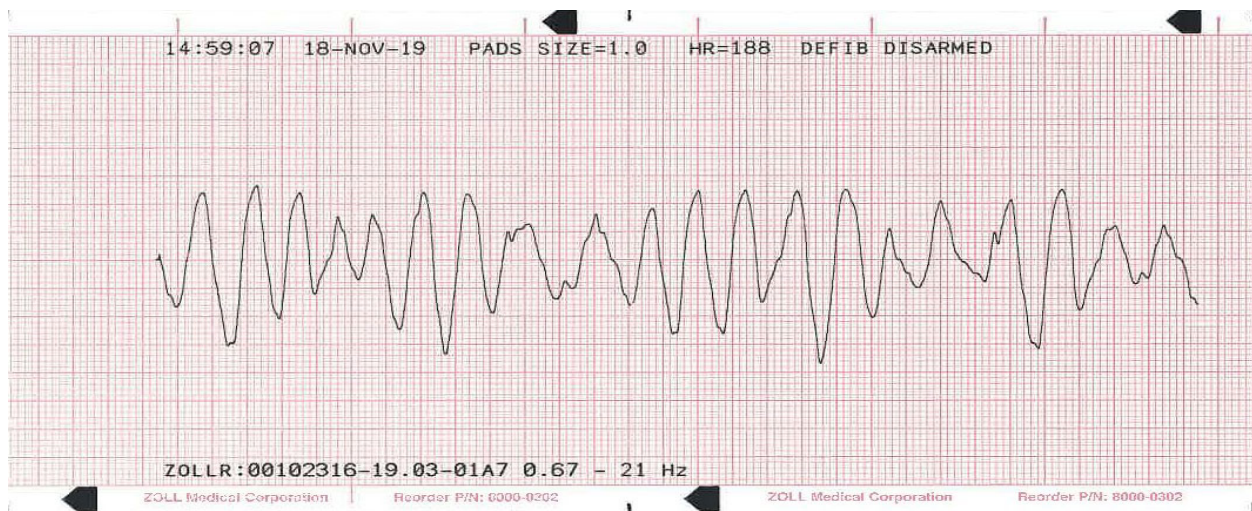

Figure 11-5. Disarm Event Format (post-Disarm)

Pacer Mode Selected Format

The summary report function records 6 seconds of pre-pace patient ECG data. Also recorded are the ECG lead, ECG size, patient's heart rate, pace rate, pace current, time and date. The date/time printed on the top of the strip corresponds to the ECG data occurring 6 seconds before the event.

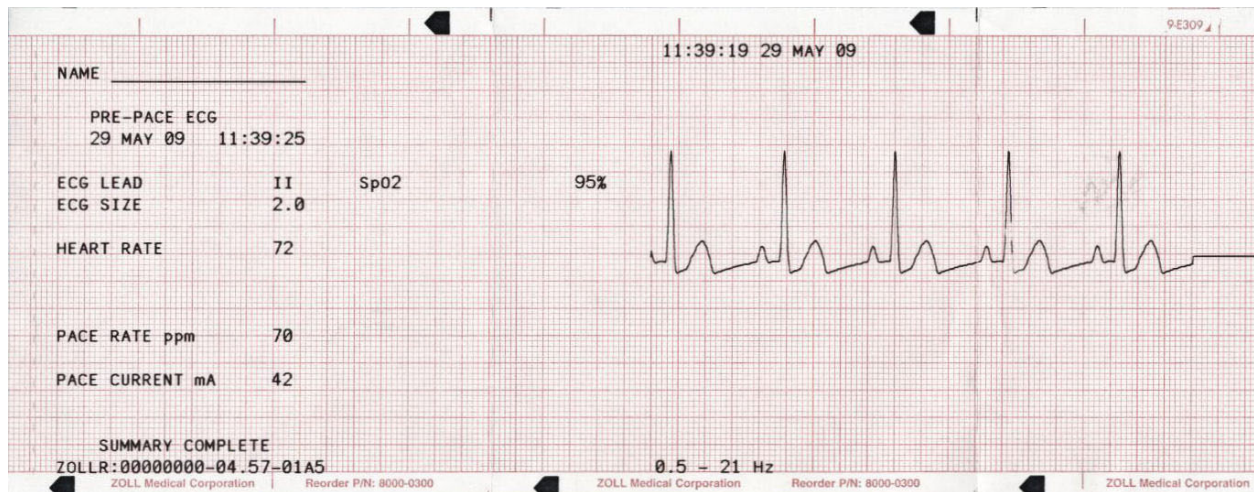

Figure 11-6. Pacer Mode Selected Format

After establishing a paced rhythm, turning the recorder on briefly records the paced rhythm for later reports. If async pace is active, the annotation *ASYNC PACE* is also recorded and printed. The date/time printed on the top of the strip corresponds to the ECG data occurring 6 seconds before the event.

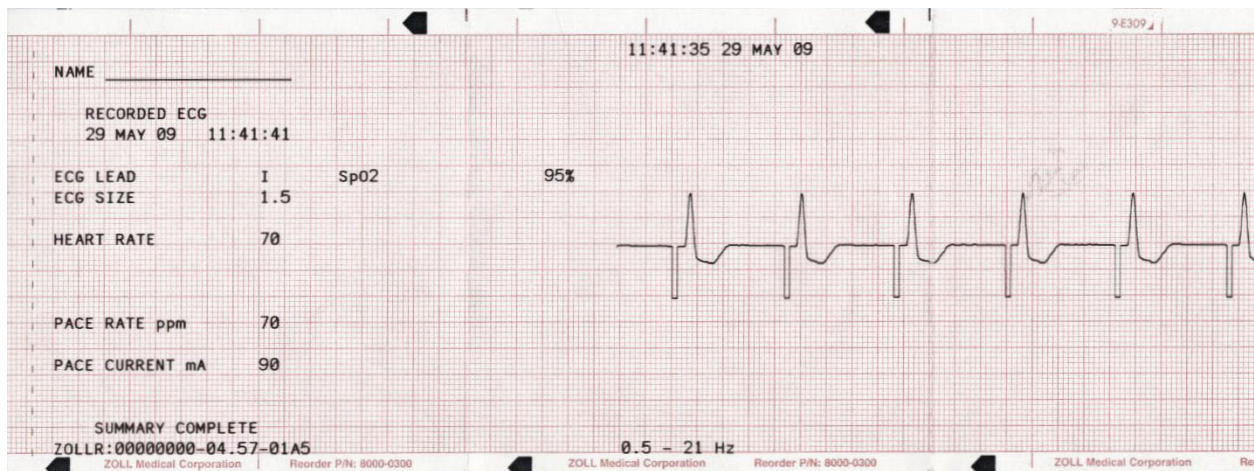

Figure 11-7. Pacer Mode Selected Format (Asynchronous Pacing)

Heart Rate Alarm Activated Format

The summary report function records 6 seconds of pre-alarm patient ECG. Also recorded are the ECG lead, ECG size, patient’s heart rate, actual event time, and date. The date/time printed on the top of the strip corresponds to the ECG data occurring 6 seconds before the event. If the pacer is on during this event, the pacing rate and pacing current are also recorded.

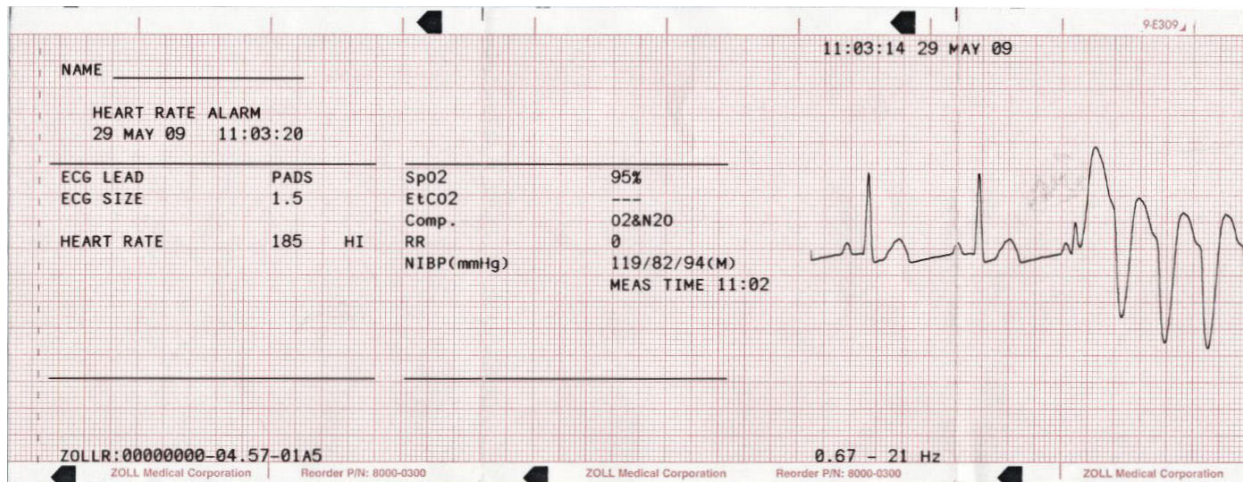

Figure 11-8. Heart Rate Alarm Activated Format

VF Alarm Activated Format

The summary report function records 18 seconds of patient ECG data associated with each VF alarm. Also recorded are the ECG lead, ECG size, actual event time, the number of noise events, and the message *CHECK PATIENT*. The date/time printed on the top of the strip corresponds to the ECG data occurring 6 seconds before the event.

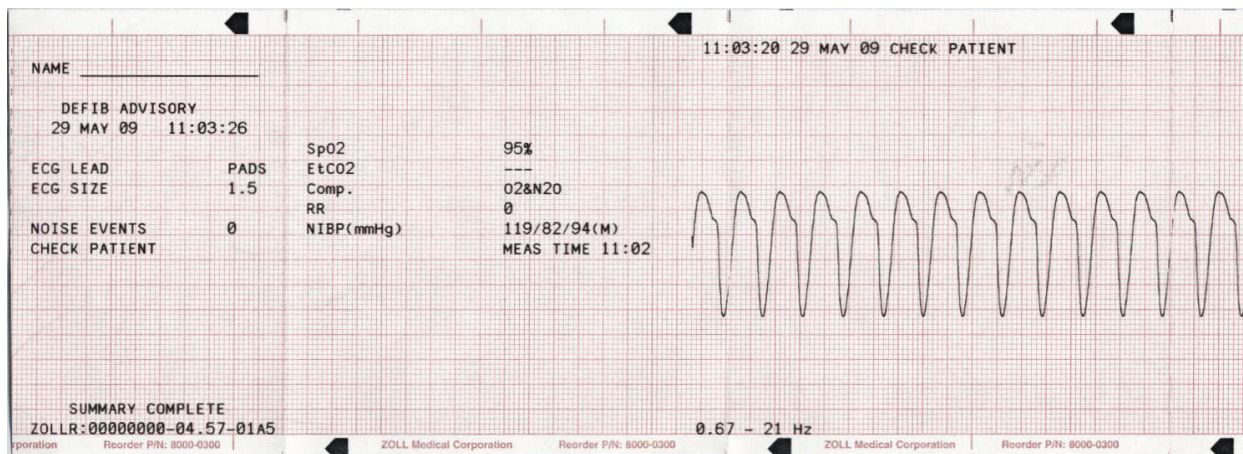

Figure 11-9. VF Alarm Activated Format

Recorder On Format

The summary report function records 6 seconds of patient ECG prior to turning on the recorder. Also recorded are the ECG lead, ECG size, patient's heart rate, actual event time, and date. The date/time printed on the top of the strip corresponds to the ECG data occurring 6 seconds before the event. If the pacer is on during this event, the pacing rate and current are also recorded. If an async pace is active, the annotation *ASYNC PACE* is recorded.

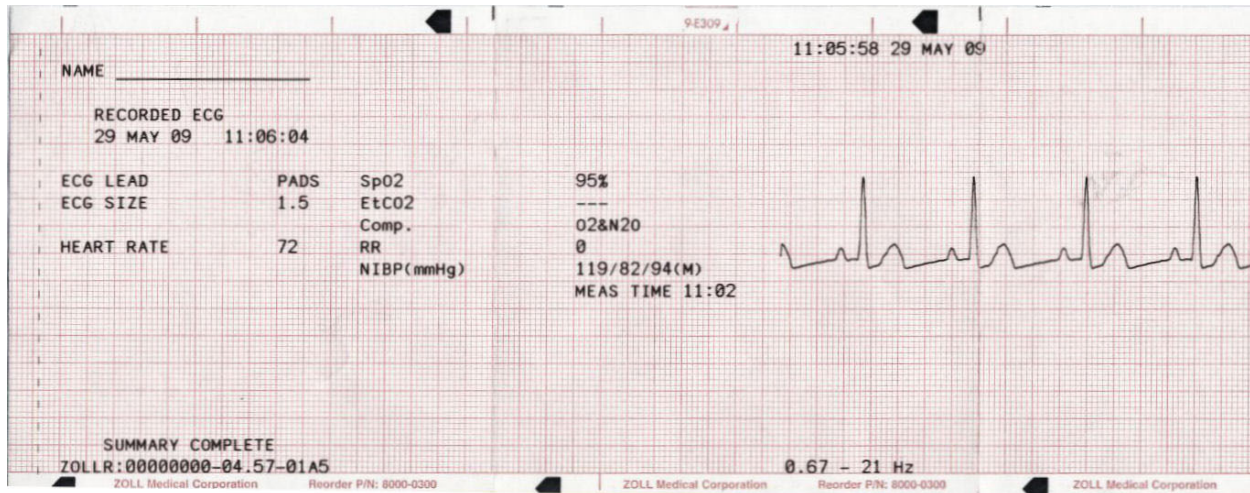

Figure 11-10. Recorder On Format

Analyze Format

The summary report function records six seconds of pre analysis ECG, 12 seconds of ECG recorded during the analysis and the annotation *SHOCK ADVISED* or *NO SHOCK ADVISED*. The date/time printed on the top of the strip corresponds to the ECG data occurring 6 seconds before the analysis was started.

The analysis normally consists of three consecutive 3-second ECG rhythm analyses. Each segment is represented at the top of the strip with either an asterisk (*) for shockable, or a dash (-) for non shockable. The unit automatically charges to the preconfigured energy level upon detection of the first shockable segment. If at least two of the three analyses determine that the patient has a shockable rhythm, the unit will prompt the operator to shock the patient. If two or more of the three 3-second ECG analyses do not detect a shockable rhythm, the unit alerts the operator that no shock is advised.

Note: If the first two segments are shockable, only two asterisks appear on the stripchart, and the third segment is not analyzed.

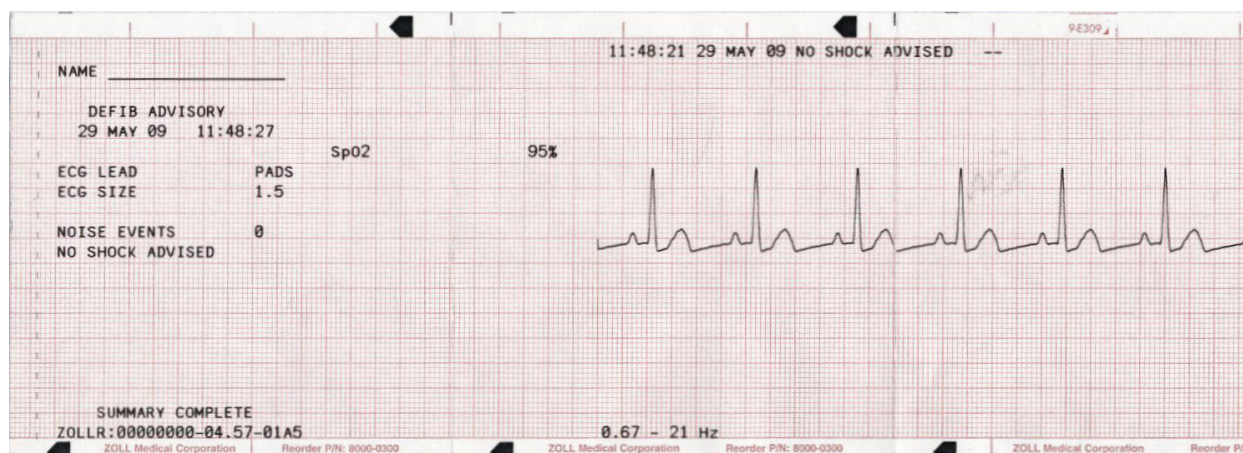

Figure 11-11. Analyze Format

In addition, the ECG rhythm analysis report can include the following annotations:

Annotation	Description
<i>POOR PAD CONTACT</i>	The hands-free therapy electrodes are improperly connected.
<i>ANALYSIS HALTED</i>	A fault condition occurred, or the operator pressed the ANALYZE button again.
<i>NOISY ECG</i>	Excessive noise was detected.
<i>SHOCK ADVISED</i>	A shockable rhythm was detected.
<i>NO SHOCK ADV.</i>	No shockable rhythm was detected.

Printing the Entire Summary Report

To print all summary report data:

1. Press the **Report Data** softkey, then press **Print Chart**.
2. Press the **Print All** softkey.

The unit prints all stored code events and code markers in chronological order beginning with the oldest entry. If the stripchart recorder is on or the defibrillator is charged, summary report printing is disabled. To stop printing a report, press the **RECORDER** button or turn off the unit. You can print an unlimited number of copies of the report by repeating this procedure.

Note: Summary report printing is interrupted when a, ECG analysis is in progress, or the defibrillator is charging or charged. Also, if a summary report is printing and you press the **Report** softkey to print another type of report (such as the log report), the device stops printing the summary report and begins printing the selected report.

If the recorder is out of paper when the **Report Data** softkey and a corresponding print softkey are pressed, a *CHECK RECORDER* message appears on the display. Load paper and press the **Report Data** softkey again to select the report to print.

Printing a Partial Summary Report

To print a partial summary report:

1. Press the **Report Data** softkey, then press **Print Chart**.
2. Press the **Print Range** softkey.
3. Use the **First Event**, **Prev. Event**, **Next Event** and **Last Event** softkeys to locate the event from which printing will start (all subsequent events are also printed).
4. Press the **Print** softkey.

The unit prints all records from the selected item to the most recent.

Note: The overview information (such as the number of shocks delivered) covers all stored summary data, not just the selected range.

Full Disclosure Recording

Along with event information captured in Summary Report, R Series also records the full disclosure CPR sensor and parameter waveforms. The full disclosure recording on the unit can accommodate at least 6 hours of data. Full disclosure recordings are erased at the same times as Summary Reports.

Incident Logs

An incident log is an abbreviated list of all major events recorded in summary report. You can print an incident log that includes the following events and their time of occurrence.

- Unit powered on.
- Unit is in Manual mode.
- Defibrillation advisory message issued (for example, *CHECK PATIENT* or *SHOCK ADVISED*)
- Shock delivered (and energy level)
- PACER mode selected
- Alarm triggered
- Stripchart printing started
- Code marker entered

In addition, the incident log lists the following:

- System serial number
- Device identification number
- Report start time (when the summary data was last erased)
- Time of the last recorded event
- Total number of shocks delivered
- Total cumulative pacing time

Printing an Incident Log

To print an incident log, press the **Report Data** softkey, then press the **Print Log** softkey.

The log is printed on the stripchart, starting with the oldest entry.

Erasing Summary Report and Full Disclosure

Summary information can be erased either manually or automatically.

Manual Erasure

You can manually erase summary records and full disclosure data from memory in preparation for collecting data for a new patient.

Note: When the event summary memory and full disclosure memory are filled, data recording stops. You must erase the records to continue recording.

Make sure to print out any important summary records currently in memory. Transfer important full disclosure records to ZOLL RescueNet.

To manually erase stored data:

1. Press the **Report Data** softkey.
2. Press the **Erase** softkey, then the **Erase Report** softkey. To erase all reports stored in the unit, press **Erase All**.

Automatic Erasure

Automatic erasure of summary report and full disclosure data occurs if the R Series unit has been turned off for a user-configurable period of 5 minutes to 72 hours.

Formatting the Disk

The R Series uses an internal flash memory disk that stores the data in files similar in structure to those on a personal computer hard drive. Like a personal computer, there may be rare occasions when the internal disk requires formatting. For example, this may occur if all power (battery and ac) is removed while erasing a report. Under such a circumstance, the message *DISK FORMAT REQ.* will be displayed. Perform the following steps to format the flash memory disk. All patient data will be erased during this procedure. If possible, print out any important summary records currently in memory and transfer important full disclosure records to ZOLL RescueNet.

1. Press the **Report Data** softkey.
2. Press the **Erase** softkey, then the **Format Disk** softkey.
3. When you are ready, press the **Confirm Format** softkey.

The messages *FORMATTING DISK* and *DO NOT POWER OFF* will be displayed while the disk is formatting. This procedure may take several minutes to complete.

Related Messages

Message	Description
<i>CHECK RECORDER</i>	The paper supply in the stripchart printer is exhausted.
<i>DISK FORMAT REQ.</i>	The internal flash memory disk file system has been corrupted. Follow the procedure in the previous section, "Formatting the Disk."
<i>DO NOT POWER OFF</i>	Do not remove power (both battery and AC) while the unit is erasing reports or formatting the disk.
<i>ERASING REPORT</i>	The unit is erasing the selected report data.
<i>FORMATTING DISK</i>	The internal flash memory disk is being formatted.

Chapter 12

File Transfer

This chapter describes procedures for transferring files from the R Series defibrillator to an external system, such as a personal computer or handheld device. It also explains how to remove, install and erase a Compact Flash card.

Note: The USB and Wi-Fi capabilities that are included in this chapter are only available if you have the R Series Plus model. The file transfer option is only available when you are in Manual mode.

While you are in Transfer Data mode, if you press any of the buttons on the right side of the front panel (**SHOCK, ANALYZE, CHARGE, ENERGY SELECT**), the following message is displayed: *SELECT DEFIB MODE*. To enable the defibrillator in Manual mode, press the **Exit Transfer** softkey, or quickly turn the Mode Selector to **OFF** and then **ON**.

Transferring Files to an External Device

You can transfer the following files from the R Series defibrillator to an external device:

- Device check, activity log, and full disclosure waveforms
- Defibrillator test information

The unit includes the following data transfer features:

- 802.11 Wi-Fi (R Series Plus Only)
- USB device connector (R Series Plus Only)
- Compact flash card slot

Note: When the unit is transferring data via Wi-Fi, it is in a non-clinical mode. No treatment or monitoring of the patient is available in this mode.

To retrieve and review event files, you may need the ZOLL RescueNet software package installed on the receiving equipment.

To retrieve and review maintenance files, you need ZOLL Device Dashboard software installed on the receiving equipment.

R Series defibrillators use the Microsoft Windows file structure for stored records. Files can be transferred to a properly equipped Windows-based personal computer or handheld device. With RescueNet, the personal computer allows the user to access the files for review.

If configured, the unit can display a reminder to transfer files while in clinical mode. When turned off, the unit displays the message *TURN UNIT ON AND ENTER DATA TRANSFER MODE TO TRANSFER REPORT* for 15 seconds. This is turned off by default; see the *R Series Configuration Guide* to change this setting.

Wi-Fi (Optional)

The R Series has an optional Wireless Ethernet function that transfers data files using the IEEE 802.11 protocol (Wi-Fi). This includes a ZOLL R Series Data COMM II card, and a protective guard that must be installed on the unit. See *R Series Data COMM II Instructions for Use and Wi-Fi Guard Installation* (Part number 9652-000405) for instructions on how to install the Wi-Fi Guard.

Do not clean the Wi-Fi Data COMM II Card with isopropyl alcohol.

All file transfer operations are terminated when the defibrillator is switched to either Defib mode or Pacing mode, or powered off.

Installing or Removing a Compact Flash Card

Before you begin, check the card and its connector to ensure that they are clean and undamaged.

To install a compact flash card:

1. Insert the card, with its label side up, into the front slot on the lower left side of the unit. You can install a compact flash card while the unit is operating or while it is turned off.
2. Slide the card into the slot until it is firmly seated.

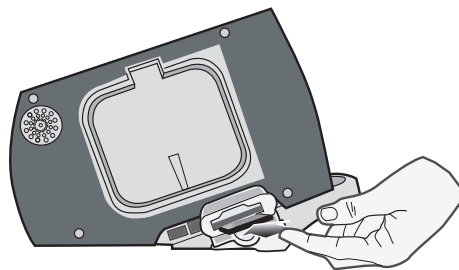

Figure 12-1. Inserting Compact Flash Card

To remove a compact flash card:

Press the release button and pull the card out of the slot.

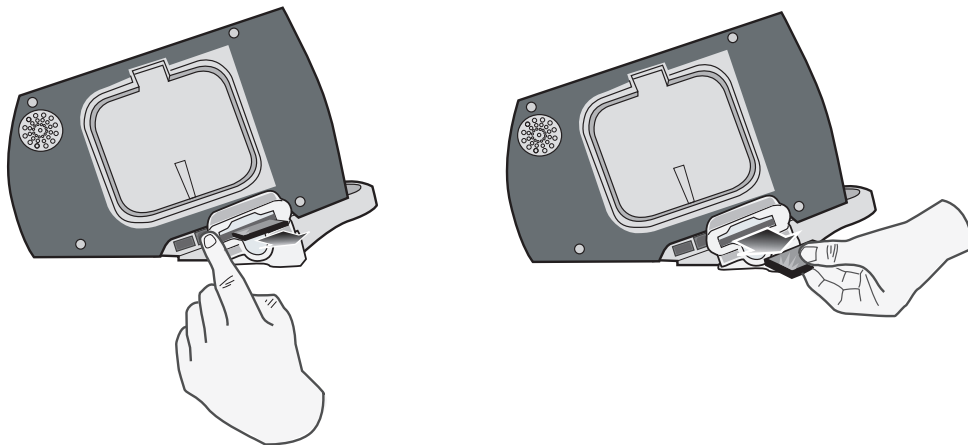

Figure 12-2. Removing a Compact Flash Card

Transferring a Full Disclosure File to a Compact Flash Card

Make sure that a compact flash card is installed in the slot on the left side of the device.

To transfer data to a compact flash card:

1. Turn the Mode Selector to **ON**.
2. Press the **Manual Mode** softkey.

Note: If the *CONFIRM MANUAL MODE* message displays, press the **Confirm** softkey to enter the Manual mode of operation.

3. Press the **Report Data** softkey.
4. Press the **Transfer Mode** softkey.
5. Press the **Report to Card** softkey.

The message *TRANSFERRING DATA* is displayed. The full disclosure file is transferred to the installed CF data card.

Note: Do not remove the CF card while files are transferring. Corruption may result on the data card.

When all files are transferred, the message *DATA TRANSFERRED* is displayed. You can now remove the CF card from the R Series unit.

To exit Data Transfer mode, press the **Exit Transfer** softkey.

Transferring Device Check and Activity Log Files to a Compact Flash Card

Make sure that a compact flash card is installed in the slot on the left side of the device.

To copy the Device Check or Activity Log to a CF card:

1. Turn the Mode Selector to **ON**.
2. Press the **Manual Mode** softkey.

Note: If the *CONFIRM MANUAL MODE* message displays, press the **Confirm** softkey to enter the Manual mode of operation.

3. Press the **Report Data** softkey.
4. Press the **Transfer Mode** softkey.
5. Press the **More** softkey.
6. Press the **Defib History to Card** softkey.

The message *TRANSFERRING DATA* is displayed. The activity log and test file is transferred to the installed CF data card.

Note: If the messages *CF TRANSFER FAILED* and then *TRANSFERRING DATA* display, make sure you have a CF card installed and not a Wi-Fi card. Press the **Return** softkey and then the **Exit Transfer** softkey to return to defibrillation operation mode.

Note: Do not remove the CF card while files are transferring. Corruption may result on the data card.

When all files are transferred, the message *DATA TRANSFERRED* is displayed. You can now remove the CF card from the R Series unit.

To exit Data Transfer mode, press the **Return** softkey and then the **Exit Transfer** softkey.

Transferring Files Through the USB Port (R Series Plus Only)

Before you begin, connect a USB cable from the Windows external device with USB host capability (for example, a Window PC), to the R Series defibrillator USB device port.

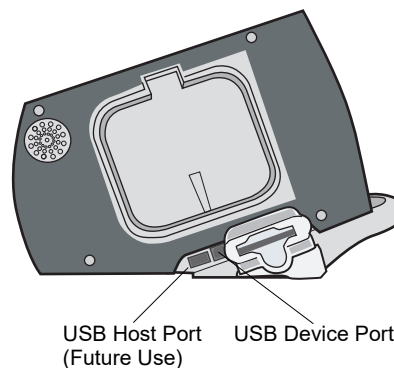

Figure 12-3. USB Ports

To transfer data through the USB port:

1. Turn the Mode Selector to **ON**.
2. Press the **Manual Mode** softkey.

Note: If the *CONFIRM MANUAL MODE* message displays, press the **Confirm** softkey to enter the Manual mode of operation.

3. Press the **Report Data** softkey.
4. Press the **Transfer Mode** softkey.
5. Press the **More** softkey.
6. Press the **Enable USB** softkey.
7. Initiate data transfer using ZOLL RescueNet.

The R Series is now in USB Transfer Mode.

To exit USB Transfer mode, press the **Disable USB** softkey or switch the Mode Selector to **OFF**.

Transferring Full Disclosure Files Through Wi-Fi (R Series Plus Only)

Before you begin, ensure the Wi-Fi card is properly seated with the name R Series Data COMM II facing up in the compact flash slot. Make sure that the Wi-Fi guard has been attached.

To transfer data through Wi-Fi:

1. Turn the Mode Selector to **ON**.
2. Press the **Manual Mode** softkey.

Note: If the *CONFIRM MANUAL MODE* message displays, press the **Confirm** softkey to enter the Manual mode of operation.

3. Press the **Report Data** softkey.
4. Press the **Transfer Mode** softkey.
5. Press the **Report to Wi-Fi** softkey.
6. The Enter Report ID screen will appear, and you will be prompted to enter a unique report ID. Use the arrow keys to select the desired characters, then press the **Enter Char** softkey. Pressing the ... key will change the table to a different set of characters, including upper case letters. To cancel and return to the previous screen, use the arrow keys and select Cancel.

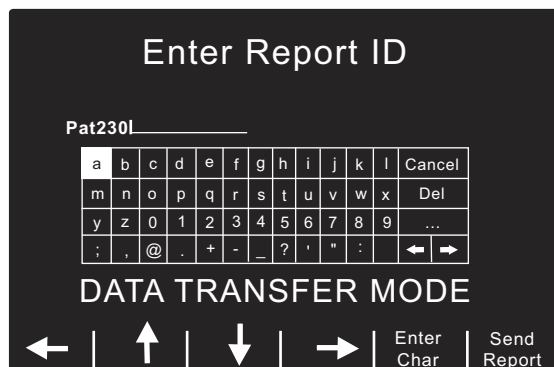

Note: Enable Report ID must be enabled in System Configuration mode for the report screen to appear (See the *R Series Configuration Guide*). If Enable Report ID is set to No, then the screen will not be displayed and the report will be sent immediately.

- To send the report, press the **Send Report** softkey. The R Series is now in Wi-Fi Transfer Mode and a status text message box appears in the middle of the screen and describes the status of the file being sent. When the full disclosure file is transferred, the messages *TRANSFER COMPLETE* and *Full Disclosure Was Sent* are displayed.

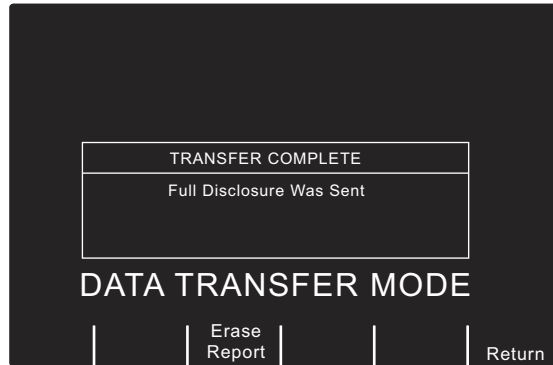

- To erase the report, press the **Erase Report** softkey. To keep the report and return to the Transfer Mode screen, press the **Return** softkey.

Note: If you are out of the range of an access point, the data will not be transferred and the message *Wi-Fi Network Not Found* is displayed. Press the **Return** softkey to return to the previous menu and try again.

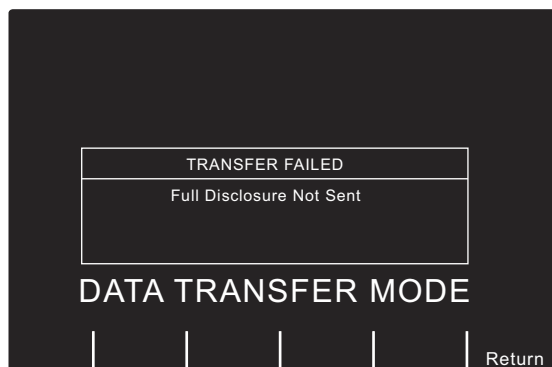

To exit Wi-Fi/DataTransfer Mode, press the **Return** softkey and then the **Exit Transfer** softkey or switch the Mode Selector to **OFF**.

Transferring Device Check and Activity Log Files Through Wi-Fi (R Series Plus Only)

Before you begin, ensure the Wi-Fi card is properly seated with the name R Series Data COMM II facing up in the compact flash slot. Make sure that the Wi-Fi guard has been attached.

To transfer data through Wi-Fi:

- Turn the Mode Selector to **ON**.
- Press the **Manual Mode** softkey.

Note: If the *CONFIRM MANUAL MODE* message displays, press the **Confirm** softkey to enter the Manual mode of operation.

3. Press the **Report Data** softkey.
4. Press the **Transfer Mode** softkey.
5. Press the **More** softkey.
6. Press the **Defib History to Wi-Fi** softkey.

The R Series is now in Wi-Fi Transfer Mode and a status text message box appears in the middle of the screen and describes the status of the files being sent. When the files are transferred, the message *TRANSFER COMPLETE* are displayed.

Note: If you are out of the range of an access point, the data will not be transferred and the message *Wi-Fi Network Not Found* is displayed.

To exit Wi-Fi/DataTransfer Mode, press the **Return** softkey and then the **Exit Transfer** softkey or switch the Mode Selector to **OFF**.

Related Wi-Fi Messages

Informational Message	Description
<i>INITIALIZING NETWORK</i>	A transfer has been initiated.
<i>CONNECTING TO THE NETWORK</i>	The association with the host network is being established.
<i>CONNECTING TO SERVER</i>	The unit is connecting to a remote system.
<i>TRANSFER IN PROGRESS</i>	The data transfer is in progress.
<i>WAITING FOR SERVER RESPONSE</i>	The unit is waiting for the final acknowledgment from a remote system.
<i>TRANSFER COMPLETE</i> <i>XX Was Sent</i> XX=file type (Full Disclosure, Activity Log, or Device check)	The data transfer is complete (and lists the file type that was sent).
Error Message	Description/Action
<i>TRANSFER FAILED</i> <i>Wi-Fi Card Not Detected</i> <i>Verify Installation of Wi-Fi Card</i>	The transfer failed because no Wi-Fi card is installed in the CF slot, or the card was ejected from the slot during transmission. Action: Make sure that the correct Wi-Fi card is properly installed in the unit.
<i>TRANSFER FAILED</i> <i>Wi-fi Card Not Configured</i> <i>Contact Network Administrator</i>	The Wi-Fi card's configuration data is corrupt or blank. Action: Verify the configuration settings on the Wi-Fi card. Contact the Network Administrator for assistance.
<i>TRANSFER FAILED</i> <i>Invalid Wi-Fi configuration</i> <i>Error Number: N</i> <i>Contact Network Administrator</i>	The transfer failed because the Wi-Fi configuration was illegal. N indicates one of following error codes: <i>N = 1: Local Static IP settings</i> 1) If running in Static IP mode, make sure that the relevant static IP addresses are not 0.0.0.0. 2) Make sure the subnet mask is in the correct format. <i>N = 2: Server Static IP address</i> Action: With DNS set to No, make sure that the IP addresses for the Full Disclosure Server and Defib History Server are not 0.0.0.0. <i>N = 3: Server Name</i> Action: With DNS set to Yes, make sure that valid names exist for the Full Disclosure Server and the Defib History Server. <i>N = 4: DNS IP address</i> Action: With DHCP set to No and DNS set to Yes, make sure that the DNS IP Address is not 0.0.0.0. <i>N = 5: SSID</i> Action: Make sure that there is at least one valid SSID for each desired mode (infrastructure and data management server).

<p><i>TRANSFER FAILED</i> <i>Invalid Wi-Fi configuration</i> <i>Error Number: N</i> <i>Contact Network Administrator</i></p> <p>(cont.)</p>	<p>N = 6: Missing required configuration data for Network Profile 1 with Enterprise Authentication selected.</p> <p>Action: Check the following:</p> <p>If Authentication Protocol is set to PEAP, make sure that the following are configured:</p> <ul style="list-style-type: none">• User Identity• User Password <p>If Authentication Protocol is set to TLS, make sure that the following are configured:</p> <ul style="list-style-type: none">• User Identity• Private Key Password• Client Certificate <p>N = 7: Missing required configuration data for Network Profile 2 with Enterprise Authentication selected.</p> <p>Action: Same as above.</p> <p>N = 8: The Data eXchange Server (DXS) Username / Password are blank within the Full Disclosure and Defib History server configuration items.</p> <p>Action:</p> <p>If Full Disclosure Transfer Mode is set to Server, make sure that the Username (Full Disclosure) and Password (Full Disclosure) entries are valid.</p> <p>If Defib History Transfer Mode is set to Manual, Automatic, or Both, make sure that the Username (Defib History) and Password (Defib History) entries are valid.</p> <p>N = 9: Missing required certificate file for Network Profile 1 with Enterprise Authentication selected.</p> <p>Action:</p> <p>If Authentication Protocol is set to PEAP, make sure that a root certificate has been added (if not using the default ZOLL root certificate).</p> <p>If Authentication Protocol set to TLS, make sure that a root certificate has been added (if not using the default ZOLL root certificate) and that the correct client certificate has been configured.</p> <p>N = 10: Missing required certificate file for Network Profile 2 with Enterprise Authentication selected.</p> <p>Action: Same as above.</p>
---	--

<p><i>TRANSFER FAILED</i> <i>Network Error: General</i> <i>Error Number: NNNN</i> <i>Contact Network Administrator</i></p>	<p>The transfer failed because of a general network Wi-Fi error. NNNN may indicate one of the following error codes:</p> <p>N = 7500 The Wi-Fi card failed to power-up.</p> <p>N = 7503 There was a problem communicating with the Wi-Fi card due to a message send error.</p> <p>N = 7504 There was a problem communicating with the Wi-Fi card due to the detection of a malformed packet.</p> <p>N = 7505 N = 7506 There was a problem communicating with the Wi-Fi card due to a timeout error.</p> <p>N = 7507 There was a problem communicating with the Wi-Fi card due to the reception of an incorrect packet.</p> <p>Action:</p> <ol style="list-style-type: none"> 1) Install another Data COMM II card. 2) Make sure that the Data eXchange Server (DXS) is running, is operational, and can be reached on the network. <p>Note: Install another card before attempting any other troubleshooting actions.</p>
<p><i>TRANSFER FAILED</i> <i>Wi-Fi Network Not Found</i> <i>Contact Network Administrator</i></p>	<p>The R Series could not associate with a Wi-Fi network.</p> <p>Action:</p> <ol style="list-style-type: none"> 1) Make sure that the configuration values for the SSID names are correct. 2) Make sure that the R Series unit is within range of the wireless server. 3) Contact the Network Administrator for assistance.
<p><i>TRANSFER FAILED</i> <i>Could Not Connect To Server</i> <i>Contact Network Administrator</i></p>	<p>The R Series could not communicate with the Data eXchange Server (DXS).</p> <p>Action:</p> <ol style="list-style-type: none"> 1) Make sure that the DXS is running, is operational, and can be reached on the network. 2) Make sure that the server port is correct.
<p><i>TRANSFER FAILED</i> <i>Network Error: DHCP</i> <i>Contact Network Administrator</i></p>	<p>The DHCP request has failed.</p> <p>Action: Make sure that the DHCP server is operational.</p>
<p><i>TRANSFER FAILED</i> <i>Network Error: DNS</i> <i>Contact Network Administrator</i></p>	<p>The DNS request has failed.</p> <p>Action:</p> <ol style="list-style-type: none"> 1) Make sure that the DNS server is running, operational, and properly configured. 2) Make sure that the R Series configuration values pertaining to the server names (Full Disclosure and Defib History) are correct.

Transferring Device Check and Activity Log Files Through Wi-Fi (R Series Plus Only)

<p><i>TRANSFER FAILED</i> <i>Full Disclosure Service Not Available</i> <i>Contact Network Administrator</i></p>	<p>The option to accept full disclosure files is not enabled on the server. Action: Contact the Network Administrator for assistance.</p>
<p><i>TRANSFER FAILED</i> <i>Defib History Service Not Available</i> <i>Contact Network Administrator</i></p>	<p>The option to accept Defib History files is not enabled on the server. Action: Contact the Network Administrator for assistance.</p>
<p><i>TRANSFER FAILED</i> <i>Server Rejection</i> <i>Contact Network Administrator</i></p>	<p>The server rejected the unit's request. Action: Contact the Network Administrator for assistance.</p>
<p><i>TRANSFER FAILED</i> <i>Unsupported Wi-Fi Card</i> <i>Verify Installation of Wi-Fi Card</i></p>	<p>The card installed in the CF slot is not an R Series Data COMM II card. Action: Make sure that the correct Wi-Fi card is properly installed in the unit.</p>
<p><i>TRANSFER FAILED</i> <i>Unsupported Wi-Fi Card</i> <i>Update Wi-Fi Card</i></p>	<p>The card installed in the CF slot is an incorrect version. Action: Install a Data COMM II card that is the latest version.</p>
<p><i>TRANSFER FAILED</i> <i>Authentication Error</i></p>	<p>The encryption passphrase/key is incorrect. Action: Contact the Network Administrator for assistance.</p>
<p><i>TRANSFER FAILED</i> <i>Invalid Certificate</i> <i>Contact Network Administrator</i></p>	<p>Could not associate to an SSID using WPA/WPA2 Enterprise security because one or more of the certificates is invalid or expired. Action: Contact the Network Administrator for assistance.</p>
<p><i>TRANSFER FAILED</i> <i>Invalid Credentials</i> <i>Contact Network Administrator</i></p>	<p>Could not associate to an SSID using WPA/WPA2 Enterprise security because one or more of the credentials were invalid. Action: Contact the Network Administrator for assistance.</p>

Chapter 13

Maintenance

Defibrillator equipment must be maintained to be ready for immediate use. The defibrillator should be tested daily. The R Series defibrillator gives you two readiness testing options:

- Automatic
- Manual

Note: Both automatic and manual test results are automatically recorded to internal memory.

Maintenance Frequency	
Visual Inspection	Once per day, inspect Code Readiness indicator.
Code Readiness Test (Automatic)	Once per day, unless configured Off, in which case, perform manual defibrillator testing daily.
Manual Defibrillator Testing	Once per week; daily if Code Readiness Test is configured Off.

When the R Series device ships from ZOLL, the Code Readiness indicator may show a red “X.” A manual readiness test should be performed (in addition to other site-specific tests such as HiPot and Leakage) prior to putting the device into service. Follow the procedure on page 12-3, and verify that the Code Readiness indicator displays a green “✓.”

Routine Procedures

Daily Visual Inspection

Equipment

Ensure that the unit is clean (with no fluid spills) and free of visible damage.

Inspect all cables, cords, and connectors for good condition (no cuts, fraying or bent pins).

Check that the paddle surfaces are clean and free of electrolyte gel and other contaminants.

Supplies and Accessories

Verify the presence, proper condition and quantity of all disposable supplies (such as ECG monitoring electrodes, electrode gel, stripchart paper, alcohol swabs, razors, and antiperspirant).

Ensure that two sets of ZOLL therapy pads are available in sealed packages. Check the expiration date on all ZOLL therapy pad packages.

Batteries/External Power Supply

Check that a fully charged battery pack is installed in the unit.

Check that a fully charged spare battery pack accompanies the unit, or that the unit has ready access to a local AC mains power outlet.

Code Readiness Status

Look at the ✓/x Code Readiness indicator on the R Series defibrillator. If the Code Readiness indicator displays a red “X” the unit is not ready for therapeutic use.

Should the automatic Code Readiness test fail, the R Series unit sets its Code Readiness indicator to a red “X”. If the failed unit is connected to AC power, it will also display a Code Readiness status report highlighting the defibrillator functions or accessories that are compromised. If the failed unit is not connected to AC power, only the red “X” will display. Connect the unit to AC power. Turn the unit **ON**, press the **Manual Mode** softkey and then the **Confirm** softkey to enter the Manual mode of operation. Press the **Report** softkey, then the **Test Log** softkey to determine the problem. Readiness test reports can be displayed and printed as described in “Code Readiness Log” on page 13-7.

Take corrective actions (for example, replace electrodes), or remove the unit from service, and consult “Troubleshooting” on page 14-1.

While a red “X” indicates the unit is not ready for therapeutic use, the device will not prevent a user from attempting to deliver therapy. An example of a condition in which therapy delivery may still be possible is when expired electrodes are connected to the device.

If a Code Readiness test has not run in 48 hours, then the indicator display will turn to a red “X.” If the device is powered on at the 48 hours mark, the indicator display turn to a red “X” when the device is powered off.

Code Readiness Test

The R Series defibrillator performs Code Readiness tests automatically to verify its integrity and readiness for emergency use. These tests verify the following:

- Battery — Verifies that the battery state of charge is sufficient for at least one hour of continuous monitoring and ten shocks at maximum energy.
- Therapy Electrodes— Verifies that OneStep Pacing, CPR, or Complete electrodes are attached to the unit and have not expired.

Note: The Code Readiness system automatically verifies the integrity of the specific electrodes listed above. Other electrodes (including members of the OneStep family) should be verified manually for connection, condition, and expiration date.

- ECG circuitry — Verifies that the ECG signal acquisition and processing electronics are functional.
- Defibrillator charge and discharge circuitry — Verifies that the defibrillator electronics are functional and can charge and discharge at 30 joules through the patient cable and into paddles, OneStep electrodes, or the Test Port.
- Microprocessor hardware and software — Verifies the proper function of the microprocessor electronics and the integrity of software.
- CPR circuitry and sensor — Verifies that the Real CPR Help circuits are functional (when OneStep CPR or Complete electrodes are attached).

To prepare for Code Readiness tests, do the following:

1. Connect the R Series to AC mains.
2. Do one of the following:
 - Connect unopened OneStep electrodes to the OneStep cable, (Unopened OneStep electrodes act as a test port. The test port capability no longer functions once the electrode package is opened and electrodes are deployed.)
 - Connect the OneStep cable to paddles, and seat the paddles in the paddle wells, (Verify adult paddles are installed and pushed all the way into the paddle wells.)or
 - Connect the OneStep or MFC cable to the test port on the R Series unit. For the MFC to CPR-D cable, use the connector that is attached to the cable.

After the successful completion of the readiness check, the Code Readiness indicator displays a green check, indicating that the unit is ready for therapeutic use. If configured, the R Series will print a test record following automatic test completion.

The unit performs an automatic device check, if configured to do so, once per day at the configured time. For information, refer to the *R Series Configuration Guide*.

Manual Defibrillator Testing

The following test performs:

- Power-on sequence check.
- **SHOCK** button and delivered energy check.
- Pacer check.
- Recorder check.

If a *LOW BATTERY* message appears during testing, the battery is close to depletion and should be replaced or recharged.

Before you begin

1. Connect the R Series to AC mains.
2. Do one of the following:
 - Connect unopened OneStep electrodes to the OneStep cable.
(Unopened OneStep electrodes act as a test port. The test port capability no longer functions once the electrode package is opened and electrodes are deployed.)
 - Connect the OneStep cable to paddles, and seat the paddles in the paddle wells,
(Verify adult paddles are installed and pushed all the way into the paddle wells.)or
 - Connect the OneStep or MFC cable to the test port on the R Series unit. For the MFC to CPR-D cable, use the connector that is attached to the cable.

Follow the instructions in either the next section, “Procedure for Testing with Paddles,” or in “Defibrillator Testing with Hands-Free Therapy Electrodes” on page 13-5.

Defibrillator Testing with Paddles

WARNING! When performing this check, use your thumbs to operate the **SHOCK** buttons in order to avoid inadvertent shock. No portion of the hand should be near the paddle electrode plates.

To test the manual defibrillation function using paddles:

1. Turn the unit off for at least 10 seconds.
2. Turn the Mode Selector to **ON**.
3. Press the **Manual Mode** softkey.

Note: If the *CONFIRM MANUAL MODE* message displays, press the **Confirm** softkey to enter the Manual mode of operation.

The unit emits a four-beep tone indicating successful completion of the power-on self-test. The ECG source is PADDLES, and ECG size is X1. “*DEFIB 120J SEL.*” appears on the display. The ECG trace appears as a solid line while the paddles are seated in the paddle wells.

4. Press the **ENERGY SELECT** buttons to set the energy to 30 joules.
5. Press the **CHARGE** button on the apex handle.
6. When the charge-ready tone sounds, press the **DISARM** softkey, or press the **ENERGY SELECT** buttons to change the selected energy to 20 joules. The defibrillator disarms itself.
7. Press the **ENERGY SELECT** buttons to reset the energy to 30 joules, if necessary.

Note: For testing, the unit discharges the defibrillator only if the energy is set to 30 joules.

8. Press the **CHARGE** button.

When the charge-ready tone sounds, the message *DEFIB 30J READY* appears.

9. Press paddles firmly into their wells and using your thumbs, simultaneously press and hold the **SHOCK** buttons (one on each paddle) until the shock is delivered.

The unit displays the message *30J TEST OK* and prints a stripchart indicating *30J TEST OK* and the delivered energy.

If the message *30J TEST FAILED* appears, contact appropriate technical personnel or the ZOLL Technical Service Department.

Defibrillator Testing with Hands-Free Therapy Electrodes

To test the manual defibrillation function using hands-free therapy electrodes:

1. Turn the unit off for at least 10 seconds.
2. Turn the Mode Selector to **ON**.
3. Press the **Manual Mode** softkey.

Note: If the *CONFIRM MANUAL MODE* message displays, press the **Confirm** softkey to enter the Manual mode of operation.

The unit emits a four-beep tone indicating successful completion of the power-on self-test. The ECG source is PADS, and ECG size is X1. *DEFIB 120J SEL* and *DEFIB PAD SHORT* appear on the display. The ECG trace appears as a solid line while the OneStep cable is connected to either the Test Port or OneStep electrodes.

4. Press the **ENERGY SELECT** buttons to set the energy to 30 joules.
5. Press the **CHARGE** button on the front panel.
6. When the charge-ready tone sounds, press the **DISARM** softkey, or press the **ENERGY SELECT** buttons to change the energy to 20 joules. The defibrillator disarms itself.
7. Press the **ENERGY SELECT** buttons to reset the energy to 30 joules, if necessary.

Note: For testing, the unit discharges the defibrillator only if the energy is set to 30 joules.

8. Press the **CHARGE** button on the front panel.
9. When the Ready tone sounds, press the **SHOCK** button on the front panel until the shock is delivered.

The unit displays the message *30J TEST OK* and prints a stripchart indicating *30J TEST OK* and the delivered energy.

If the message *30J TEST FAILED* appears, contact appropriate technical personnel or the ZOLL Technical Service Department.

A manual defibrillation test can be done in AED mode only if the Code Readiness indicator shows a red "X" and the OneStep cable is connected to either unopened OneStep electrodes or the test port.

To test the defibrillation function in AED mode using hands-free therapy electrodes:

1. Turn the unit off for at least 10 seconds.
2. Turn the Mode Selector to **On**.

The unit emits a four-beep tone indicating completion of the power-on self-test, displays **CHECK PADS**, and issues the voice prompt. The ECG trace appears as a solid line while the OneStep cable is connected to either the Test Port or OneStep electrodes.

3. Press the **Manual Test** softkey. The unit charges to 30 joules.
4. When the Ready tone sounds, press the **SHOCK** button on the front panel until the shock is delivered.

The unit displays the message *30J TEST OK* and displays a shock count of 1.

If the message *30J TEST FAILED* appears, contact appropriate technical personnel or the ZOLL Technical Service Department.

Pacer Testing

1. Turn the Mode Selector to **ON**.
2. Press the **Manual Mode** softkey.

Note: If the *CONFIRM MANUAL MODE* message displays, press the **Confirm** softkey to enter the Manual mode of operation.

3. Turn the Mode Selector to **PACER**.
4. Turn the **PACER RATE** control to 150 ppm, then press the **RECORDER** button.

On the stripchart, verify that pacing stimulus markers () occur approximately every centimeter (10 small divisions or 2 large divisions).

5. Press and hold the **4:1** button.

The frequency of the pacing stimulus markers decreases, occurring approximately every 4 centimeters (40 small divisions or 8 large divisions).

6. Turn the **PACER OUTPUT** control to 0 mA.

There should be no *CHECK PADS* or *POOR PAD CONTACT* messages.

7. Disconnect the OneStep cable from the test port or OneStep electrodes, and slowly turn the **PACER OUTPUT** control to 16 mA or more.

The messages *CHECK PADS* and *POOR PAD CONTACT* appear alternately. The pace alarm sounds, and the **Clear Pace Alarm** softkey flashes.

8. Reconnect the OneStep cable, and press the **Clear Pace Alarm** softkey.

The messages *CHECK PADS* and *POOR PAD CONTACT* disappear, and the alarm tone stops.

Recorder Check

1. Turn the Mode Selector to **ON**.
2. Press the **Manual Mode** softkey.

Note: If the *CONFIRM MANUAL MODE* message displays, press the **Confirm** softkey to enter the Manual mode of operation.

3. Select the ECG lead.
4. Check the printer for an adequate supply of paper, then press the **RECORDER** button.
5. Press and hold the **SIZE** button for at least 2 seconds.

A calibration pulse of 1 mV appears on the display while the button is held. The amplitude of the calibration pulse is independent of the **SIZE** setting.

6. Inspect the recorder waveform for uniformity and darkness.
7. Inspect for uniformity of annotated characters and completeness of words.
8. Check the printer speed by verifying that the resulting waveform is:
 - 2.5 mm \pm 0.5 mm wide
 - 10 mm \pm 1.0 mm high

Code Readiness Log

Each automatic and manual defibrillation test result is stored in internal non-volatile memory, the Code Log. A total of 1000 Code Readiness test records can be stored in internal memory. When the Code Readiness Log is full, the oldest records are erased on a first-in-first-out (FIFO) basis.

The Code Readiness Log can be transferred to an external computing device (see “Transferring Files to an External Device” on page 12-1).

If configured, the R Series prints a Code Readiness Test Report following the completion of each automatic defibrillator test.

To print the Code Readiness Log:

1. Turn the Mode Selector to **ON**.
2. Press the **Manual Mode** softkey.

Note: If the *CONFIRM MANUAL MODE* message displays, press the **Confirm** softkey to enter the Manual mode of operation.

3. Press the **Report Data** softkey.
4. Press the **Test Log** softkey.

A menu appears with the print options.

5. To print a specific test, use the **Prev Test** and **Next Test** softkeys to select the test, then press **Print Test**, or press **Print Test Log** to print the log of all of the tests.

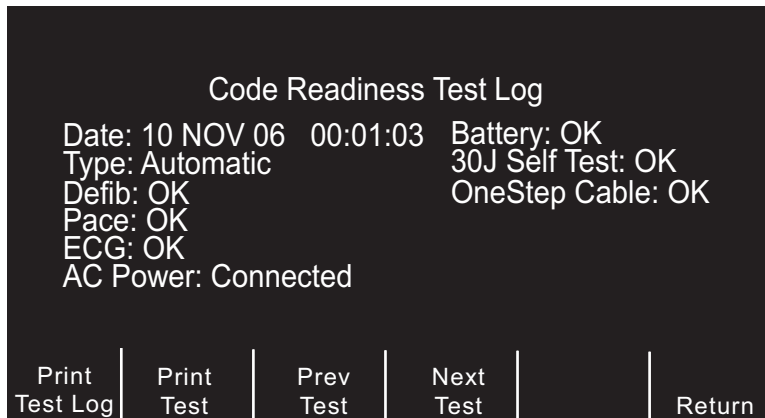

Figure 13-1. Code Readiness Test Log Print Display

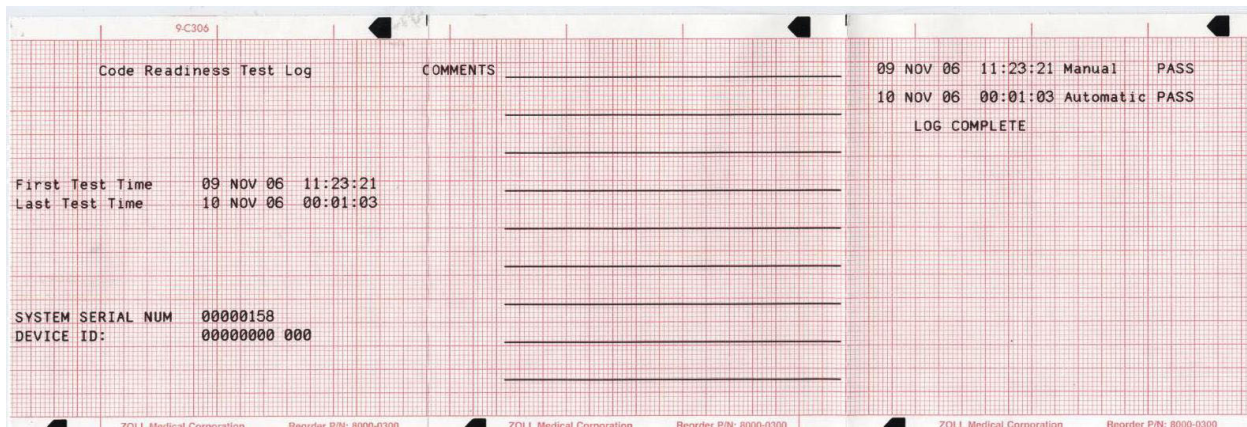

Figure 13-2. Code Readiness Test Log

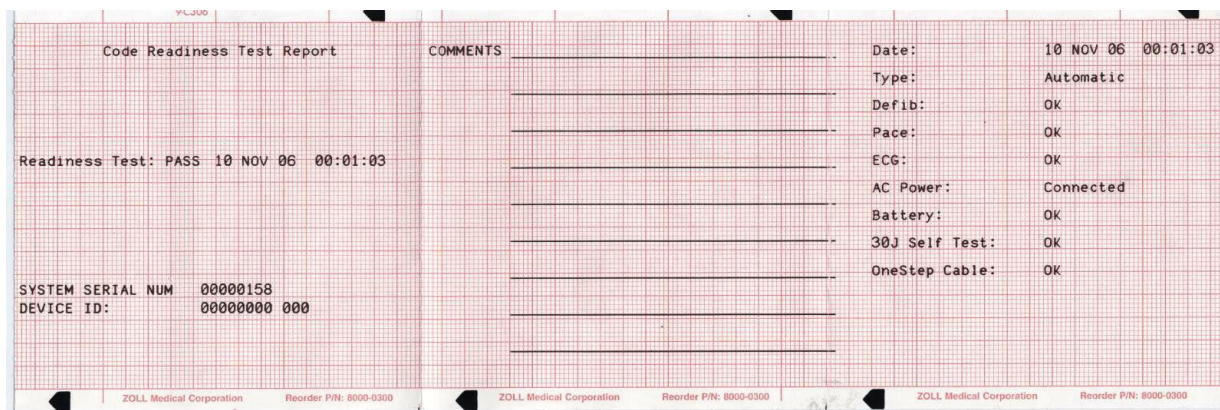

Figure 13-3. Code Readiness Test Report

Setting Time and Date

To set the unit’s time and date:

1. Turn the Mode Selector to **ON**.
2. Press the **Manual Mode** softkey.

Note: If the *CONFIRM MANUAL MODE* message displays, press the **Confirm** softkey to enter the Manual mode of operation.

3. Press the **Options** softkey.
4. Press **More**.
5. Press **Set Clock**.

The month field will be highlighted.

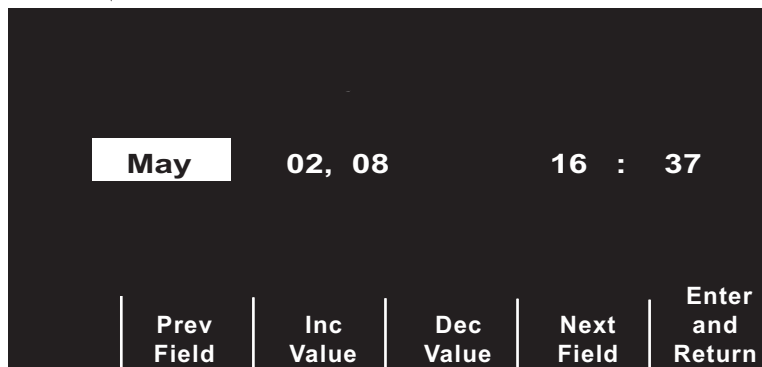

Figure 13-4. Set Time Screen

6. Press the **Inc Value** or **Dec Value** softkeys to select the appropriate month.
7. Press the **Next Field** softkey to set the selected month, and move the highlight to the next field (day).
8. Repeat steps 5 and 6 to set the correct day, year, hours, and minutes values.

Note: The last field does not automatically scroll (wrap) to the beginning. You must press the **Prev Field** softkey to enter the values for the previous field. If you need to make corrections, press the **Prev Field** softkey to move the highlight to the field previously entered.

9. Press the **Enter and Return** softkey to set all values and return to normal monitoring mode.

Note: The R Series unit may be configured to synchronize the time automatically with a data server in the Wi-Fi Data Transfer configuration settings. See the *R Series Configuration Guide* for more information.

Cleaning the R Series Unit

To clean the R Series unit, use a nearly dry cloth containing one of the mild cleaning agents listed below. DO NOT allow cleaning agent or water to run into the crevices or connector openings at any time. Thoroughly wipe off any excess cleaning solution from the R Series unit with a dry cloth.

Always check monitor and connector opening for unusual wear, damage or dampness while cleaning.

Follow the directions on the product label for use and storage of all cleaning agents.

Use only these recommended cleaning agents:

- Clinell® Universal Wipes
- Ethanol Disinfection with detergent
- Super Sani-Cloth® Wipes
- Sani-Cloth Plus® Wipes
- Oxivir® TB Wipes
- CaviWipes® XL Wipes
- Clorox Healthcare Hydrogen Peroxide Wipes
- 70% Isopropyl Alcohol (IPA) Wipes

- Sodium Hypochlorite (Bleach) Solution or Wipes (up to 10,000 ppm)
- Hydrogen Peroxide Solution
- Wex-Cide® 128 Solution
- Coverage Spray HB Plus
- Warm water and soap

Cleaning Cables and Accessories

Cables, cuff tubing, paddles and other accessories can be wiped clean with the recommended cleaning agents listed above.

Loading Stripchart Paper

The unit displays the message *CHECK RECORDER* when the printer is activated without paper or if the supply runs out during printing.

Use *ZOLL* stripchart paper (Part number 8000-0300).

To load paper into the stripchart printer:

1. Press the release button and allow the printer door to open, then remove any paper.

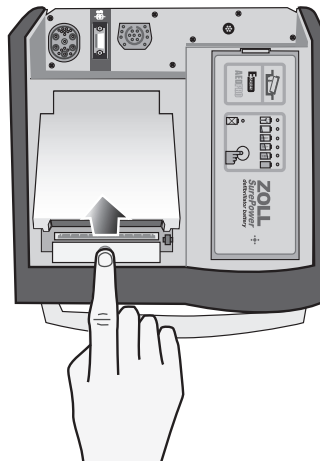

Figure 13-5. Opening the Printer Door

2. Refer to the illustration inside of the paper compartment for proper paper orientation, and place a new pad of stripchart paper in the tray.

Note: Paper feeds from the top of the stack with gridlines facing down.

3. Pull enough paper off the pad so that paper extends out of the unit when the printer cover is closed.
4. Close the printer cover by pressing down lightly on the edge of the cover next to the release button. Be sure the cover is flush with the top of the device.

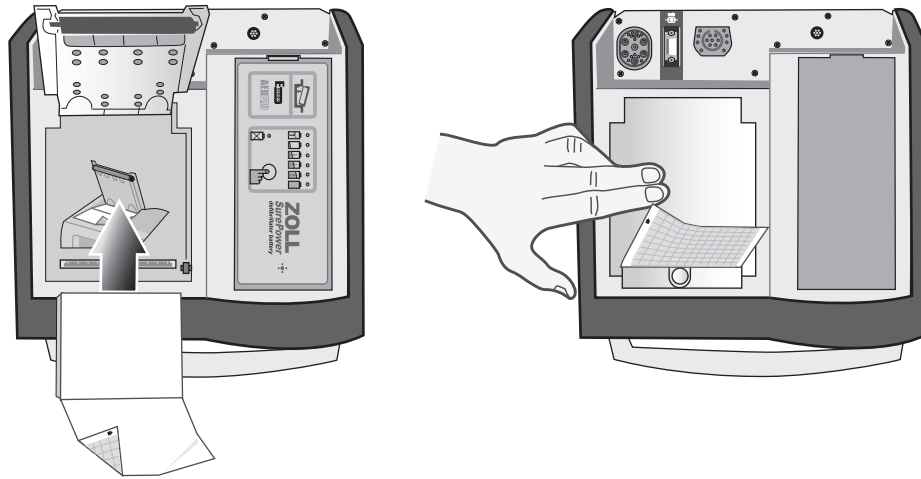

Figure 13-6. Inserting the Paper and Closing Printer Door

After the paper is loaded, press the **RECORDER** button to resume printing.

Note: To ensure you have loaded the paper properly, check to make sure the arrows printed on the red, grid side of the paper point upward.

Cleaning the Print Head

To clean the recorder print head, perform the following steps:

1. Press the release button, and allow the printer door to open (see Figure 13-5); then remove any paper.
2. Locate the printhead along the front floor of the printer compartment, just below the release button.
3. Gently wipe the printhead with a cotton swab moistened with isopropyl alcohol, and dry any residual alcohol with another dry cotton swab.

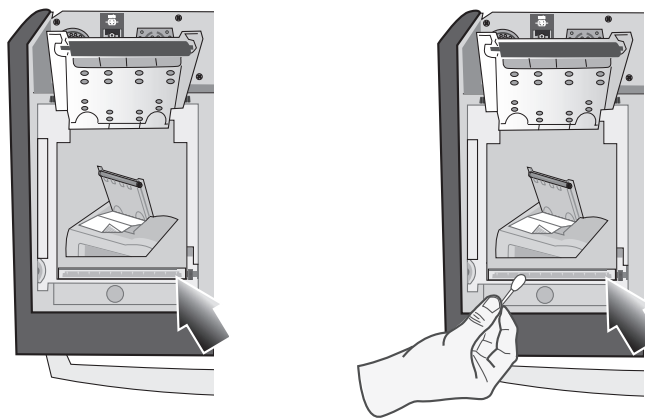

Figure 13-7. Cleaning the Print Head

4. Place the paper back into the unit and close the cover (see Figure 13-6).

Operator's Checklist for R Series Product

Recommended checks and procedures to be performed daily or weekly, depending on Automatic Test configuration.

Date _____

Location _____

Unit Serial Number _____

1. Condition	Remarks
Unit clean, no spills, clear of objects on top, case intact	
2. Hands-free Therapy electrodes	
1 set preconnected / 1 spare	
3. Paddles	
Paddles clean, not pitted	
Release from housing easily	
4. Inspect cables for cracks, broken wires, connector	
A ECG electrode cable, connector	
B Defibrillator paddle cables	
C OneStep cable, connector	
D Other patient cables	
5. Batteries/External power supply	
A Fully charged battery in unit	
B Fully charged spare battery available, or ready access to local AC mains	
6. Disposable supplies	
A Defib gel or gel patches	
B Hands-free therapy electrodes in sealed packages — 2 sets	
C ECG electrodes	
D Recorder paper	
E Alcohol wipes	
F Razors	
7. Operational checks	
A Power On Sequence	
Turn unit to ON, 4-beep tone heard, AED label and ON Mode Selector light up	
Press Manual Mode softkey, press Confirm softkey, front panel lights up	
ECG size X 1	
"PADDLES" or "PADS" as lead selected	
B Paddles	
Paddles in holder: Set defib energy level to 30 joules, press paddles firmly into the side wells, and simultaneously press and hold both defib discharge buttons; "30J TEST OK" message on Recorder.	
C Defibrillator	
OneStep Cable connected to test connector or OneStep Electrodes. Set defib energy level to 30 joules, press CHARGE button, press DISARM softkey or use Energy Select arrows to disarm down to 20 joules. After it disarms, use Energy Select arrows to select 30 joules (if necessary), press CHARGE button, then SHOCK button. "30J TEST OK" message displayed.	
D Pacer Operation (If installed)	
OneStep cable not connected to Test Connector or OneStep electrodes	
Turn to PACER, set pacer rate to 150 ppm, press RECORDER button	
Pacer pulses occur ever 2 large divisions (10 small divisions)	
Press 4:1 button, pulses occur every 8 large divisions	
Set PACER OUTPUT to 0 mA, no CHECK PADS message	
Set PACER OUTPUT to 16 mA, CHECK PADS message and alarm	
Reconnect OneStep cable to test connector, or OneStep electrodes. Press Clear Pace Alarm softkey; CHECK PADS message disappears and Pace alarm stops.	
E Recorder	
Press RECORDER button; Recorder runs. Press again; Recorder stops.	
Inspect Recorder printing	
8. Please check the appropriate box after each use of this checklist.	Signature
No action required	_____
Minor problem(s) corrected	
Disposable supplies replaced	
Major problem(s) identified — UNIT OUT OF SERVICE	

Chapter 14

Troubleshooting

The troubleshooting information provided in this chapter is intended for use by nontechnical medical personnel during device operation. This chapter answers many of the common problems or questions that may arise during operation.

If trouble persists after consulting this guide, contact the appropriate technical personnel or ZOLL Technical Service Department. Refer to the *R Series Plus/BLS Service Manual* for more detailed troubleshooting information.

Code-Ready

Symptom	Recommended Action
1. Code Readiness indicator displays a red "X" while unit is turned off.	Turn the unit on. Print Code Readiness log as described on page 13-7. Follow messages and prompts to resolve the problem.
2. Code Readiness indicator displays a red "X" while unit is powered on.	Turn the unit off and then on again. Follow messages and prompts to resolve the problem. Perform a Manual Defibrillator test as described in "Manual Defibrillator Testing" on page 13-3. If the unit continues to fail, take it out of service and contact ZOLL Technical Service.
3. Pad Expired; Replace Pads	Check the expiration date on OneStep electrodes, and replace them if they are expired.

Monitor

Symptom	Recommended Action
1. Unit does not turn on or unexpectedly shuts off.	<ul style="list-style-type: none"> • Check that battery pack is properly installed. • Verify the unit is plugged into AC power. • Replace battery pack with a fully charged battery pack.
2. <i>X FAULT XX</i> message	<ul style="list-style-type: none"> • A fault has been detected. • Attempt to clear the <i>X FAULT XX</i> message by turning the Mode Selector to OFF for more than 10 seconds, then back to the desired operating mode. <p>Note: Some settings (e.g. alarm settings, lead selection, ECG size) may need to be restored.</p>
3. <i>SET CLOCK</i> message	<ul style="list-style-type: none"> • Set time and date information. • Verify that the internal lithium battery has been replaced within the last 5 years. Contact ZOLL Technical Service Department for assistance
4. <i>ECG LEAD OFF</i> message	<ul style="list-style-type: none"> • Check that ECG cable or OneStep Pacing cable is connected to patient and instrument. • Check that ECG electrodes or OneStep Pacing or Complete electrodes are making good contact and are not dried out. • If changing from 5-lead ECG patient cable to 3-lead ECG patient cable, remove the 5 lead cable then turn unit OFF for at least 10 seconds. • Replace ECG cable or OneStep cable.
5. <i>POOR LEAD CONTACT</i> message	<ul style="list-style-type: none"> • Check that ECG cable or OneStep Pacing cable is connected to patient and instrument. • Check that ECG electrodes or OneStep Pacing or Complete electrodes are making good contact and are not dried out. • If changing from 5-lead ECG patient cable to 3-lead ECG patient cable, remove the 5 lead cable then turn unit OFF for at least 10 seconds. • Replace ECG cable or OneStep cable.
6. Noisy ECG, artifact, wandering baseline	<ul style="list-style-type: none"> • Consider 1 – 21Hz filter bandwidth (see <i>R Series Configuration Manual</i>). • Prepare the patient's skin prior to electrode attachment. • Check for proper adhesion of electrodes to patient. • Reduce or eliminate ECG artifact due to electrode or patient cable movement. Route cables so that they don't pull on electrodes or swing excessively. • Ensure patient is motionless. • Check for possible excessive radio frequency interference.
7. Poor ECG signal amplitude, calibration pulse normal	<ul style="list-style-type: none"> • Select another lead. • Apply new electrodes using different placement.

Symptom	Recommended Action
8. Inconsistent QRS beep or heart rate	<ul style="list-style-type: none">• Select another lead.• Alter ECG electrode placement.
9. Sync marker is absent or inconsistent with QRS waveform on display and recorder	<ul style="list-style-type: none">• Ensure device is in Sync mode.• Ensure that device is NOT in Remote Sync mode.• Change ECG lead selection.• Alter ECG electrode placement.• Paper too narrow. It should be 90 mm wide.
10. No ECG trace or dashed line on display	<ul style="list-style-type: none">• Device is in Remote Sync mode. Press the Sync On/Off softkey to exit Remote Sync mode.
11. CPR Remaining Timer is enabled but fails to decrement	<ul style="list-style-type: none">• Turn unit off for 10 seconds and then turn it back on again.
12. Alarm tone sounds when unit is turned on but alarm feature is not enabled	<ul style="list-style-type: none">• Press the ALARM SUSPEND button.

Recorder

Symptom	Recommended Action
1. <i>CHECK RECORDER</i> message	<ul style="list-style-type: none"> Recorder out of paper. Remove paper, check paper type, check recorder for paper jam, and reload paper. Recorder door is open. Paper is loaded upside down.
2. Recorder makes stuttering sound when activated.	<ul style="list-style-type: none"> Check recorder for paper jam.
3. Light or poor quality printing	<ul style="list-style-type: none"> Ensure correct paper is in use. Ensure paper is installed grid side against recorder print head. Recorder print head requires cleaning.
4. Summary Report will not print when Report/Print Chart softkeys are activated.	<ul style="list-style-type: none"> 15 seconds have not elapsed since one of the events that trigger Summary Report to record have occurred. Wait 15 seconds, then try again.

Pacer

Symptom	Recommended Action
1. <i>CHECK PADS</i> message	<ul style="list-style-type: none"> Ensure therapy electrodes are connected to the OneStep cable. Ensure electrode gel is not dry. Replace therapy electrodes if necessary. Ensure good electrode-to-patient contact. Check integrity of OneStep cable by plugging into test connector. <i>CHECK PADS</i> should disappear.
2. No stimulus marker () is present on the ECG trace.	<ul style="list-style-type: none"> Ensure unit is in PACER mode. Ensure PACER RATE (ppm) is set greater than patient heart rate.
3. No ventricular capture beat appears after stimulus marker on ECG display.	<ul style="list-style-type: none"> Check patient's pulse. Increase output current. Ensure therapy electrodes are making good contact with the patient. Select different ECG Lead configuration. Review therapy electrode placement.

Symptom	Recommended Action
4. Patient on "Standby" pacing gets paced intermittently.	<ul style="list-style-type: none"> • Ensure proper ECG electrode or OneStep Pacing/ Complete electrode connection and placement. If ECG lead wire comes off, pacer will automatically pace asynchronously. • Check ECG cable for damage. • Patient R-to-R interval varying. Pace rate close to patient's heart rate. • Verify rate is set appropriately.
5. Heart rate display reads 0 with proper pacing capture displayed on ECG trace.	<ul style="list-style-type: none"> • Check patient's pulse. • Select different ECG Lead configuration.
6. Bedside/Central Station/Telemetry ECG display becomes erratic when pacing.	None, the patient monitor ECG inputs are overloaded by pacer signals. ECG can only be monitored by the R Series or pacing device while pacing.

Defibrillator

Symptom	Recommended Action
1. Excessive artifact detected when using paddles as ECG source.	<ul style="list-style-type: none"> • Ensure "PADDLES" is selected. • Firmly press paddles against patient skin. • Use gel on paddles. • Clean paddle surface. • Check and clean between adult and pediatric plate. • Check cable for damage. • Use ECG electrodes.
2. Defibrillator will not charge (energy level does not increment on display).	<ul style="list-style-type: none"> • Ensure that SHOCK button(s) on paddles or front panel are not stuck on. • Replace the battery pack.
3. Charge time to 200 J exceeds 10 seconds.	<ul style="list-style-type: none"> • Typical in a low battery condition (up to 20 seconds) • Plug device into AC power. • Install fully charged battery pack.

Symptom	Recommended Action
4. Energy does not discharge when the SHOCK button(s) is pressed.	<ul style="list-style-type: none"> • 60 or 120 seconds (user configurable) have elapsed in Manual mode since initial charge ready. Energy was internally discharged. • Device is in Sync mode or Remote Sync mode and no QRS complex is detected. • Energy internally discharged because energy selection was changed during charge or after the device was ready. • Unit was not completely charged when SHOCK button(s) were pressed. Wait for <i>DEFIB XXXJ READY</i> message and ready tone. • Press and hold SHOCK button(s) until energy is delivered to the patient. • Pads or paddles not making good contact with patient.
5. Unable to SHOCK when in Sync mode	<ul style="list-style-type: none"> • Ensure <i>SYNC XXXJ SEL</i> is displayed on monitor. • Make sure ECG signals are displayed. • Check for Sync markers (arrow above R wave). If not present, change lead selection, or electrode placement. • Press and hold SHOCK button(s) until energy is delivered to the patient. • Alter ECG electrode placement.
6. Unable to SHOCK when in Remote Sync mode	<ul style="list-style-type: none"> • Ensure <i>REMOTE SYNC</i> is displayed in place of the ECG waveform and that <i>REMOTE SYNC XXXJ SEL</i> is displayed. • Ensure that a remote device conforming with the Sync In/Marker Out specifications in Appendix A is properly connected. • Ensure that Sync markers appear with each R-wave on the remote device's display. If Sync markers are not present on the remote device's display or do not appear to be nearly simultaneous with each R-wave, do not proceed with synchronized cardioversion. • Press and hold SHOCK button(s) until energy is delivered to the patient.
7. No apparent energy delivery to patient	<ul style="list-style-type: none"> • Under certain circumstances, some patients will not show a physical reaction when energy is delivered. • Perform defibrillator self-test. • Check for <i>CHECK PADS</i> and <i>POOR PAD CONTACT</i> messages alternating on the monitor. • If hands-free therapy electrodes are used, ensure proper placement and contact. • Review the discharge stripchart for Joules/current delivered.

Symptom	Recommended Action
8. <i>CHECK PADS</i> or <i>ATTACH PADS</i> message	<ul style="list-style-type: none"> • Verify proper OneStep cable / hands-free therapy electrode connection by disconnecting and reconnecting the OneStep cable and hands-free therapy electrodes. • Ensure proper contact of hands-free therapy electrodes and that the patient does not have excessive hair beneath the electrodes. • OneStep cable is defective. If message persists, disconnect OneStep cable from therapy pads, and plug cable into test connector. <i>CHECK PADS</i> or <i>ATTACH PADS</i> should change to <i>DEFIB PAD SHORT</i> (Manual mode only). • Try using paddles to defibrillate.
9. <i>SELECT PADS</i> message	<ul style="list-style-type: none"> • ECG Analysis will operate only when hands-free therapy electrodes are attached to the patient. • Disconnect paddle, and connect hands-free therapy electrodes for use in Advisory defibrillation. • Activate Manual mode to use Paddles.
10. <i>NOISY ECG RETRY ANALYSIS</i> message	<ul style="list-style-type: none"> • Check for proper application and adhesion of hands-free therapy electrodes. • Check to make sure that nobody is touching the patient and that the patient is motionless.
11. No 30J <i>TEST OK</i> message is displayed when performing a manual defibrillator self-test.	<ul style="list-style-type: none"> • Check to make sure unit is set to 30 joules. • If testing with OneStep electrodes, make sure that the OneStep cable patient connector is firmly inserted into the electrode connector. Ensure the OneStep electrode package is sealed. • If testing with the Test Port, make sure the OneStep cable is firmly inserted into the Test Port. • If testing with paddles, make sure to press the paddles firmly into the paddle wells while discharging.
12. <i>DEFIB MAINT. REQ.</i> message	<ul style="list-style-type: none"> • Indicates that the device has delivered 5000 shocks at the maximum energy of 200 joules. Only 200 joule shocks are counted. The device is still usable; if you are responding to a code, continue using the device. Contact ZOLL Technical Service Department when possible.

AC Charger

Symptom	Recommended Action
1. The Battery indicator is alternately illuminating green and yellow.	<ul style="list-style-type: none"> • Verify battery is installed. • Turn unit ON to identify the fault condition. • Replace battery pack with a fully charged battery pack. • If problem persists, replace battery pack, unplug device from AC mains for more than 10 seconds and plug device back into AC mains.
2. <i>LOW BATTERY</i> message appears on monitor when unit is plugged into AC mains.	<ul style="list-style-type: none"> • Verify that the AC Power Indicator is illuminated. • If not, check AC power cord connection at the wall outlet and at the rear of the device. • Replace battery pack with a fully charged battery pack. • Unplug device from AC mains, and plug device back into AC mains. • Verify AC mains is working properly.
3. Neither the Battery, nor AC Power indicator is illuminated when the device is plugged into AC mains.	<ul style="list-style-type: none"> • Unplug device from AC mains, and plug device back into AC mains. • Verify AC mains is working properly.

CPR

<i>CHECK CPR PUCK</i> message is displayed.	<ul style="list-style-type: none"> • No action is required. This is an informational message to indicate that default calibration values are being used for the CPR puck. The CPR values will be within the specification.
---	---

Appendix A

Specifications

This section describes the specifications for the R Series Defibrillator as well as the ECG rhythm analysis algorithm.

- “Defibrillator Specifications” on page A-2
- “Battery Pack Specifications” on page A-8
- “IEC 60601-1-2 Specifications” on page A-8
- “R Series Rectilinear Biphasic Waveform Characteristics” on page A-13
- “Clinical Trial Results for the Biphasic Waveform” on page A-25
- “ECG Rhythm Analysis Algorithm Accuracy” on page A-30

Defibrillator Specifications

General	
Size (height • width • length)	8.2 in. • 10.5 in. • 12.5 in. with handle or 10.0 in. without handle 20.8 cm • 26.7 cm • 31.7 cm with handle or 25.4 cm without handle
Weight	13.6 lb (6.17 kg) with OneStep cable and battery pack 15.2 lb (6.89 kg) with paddles
Power (for R Series ALS, BLS and Plus models)	Battery: Rechargeable lithium ion battery pack AC Power Requirements: 100-120 Vrms, 50/60 Hz 220-240 Vrms, 50 Hz AC Power Consumption: 275 VA maximum
Device classification	Class I and internally powered per EN 60601-1.
Design standards	Meets or exceeds applicable requirements of: IEC 60601-1: 2005 + CORR. 1 (2006) + CORR. 2 (2007) IEC 60601-2-4: 2010 (Third Edition) EN 61000-4-6, EN 61000-4-8, and EN 61000-4-11 as pertains to EN 60601-1-2 (4th Edition). IEC 60601-2-27: 2011 (Third Edition) IEC 60601-2-49 (Second Edition): 2011 IEC 80601-2-30:2009 ISO 80601-2-55:2011 (First Edition) for use with IEC 60601-1: 2005 (Third Edition) + CORR.1 (2005) + CORR. 2 (2007) ISO 80601-2-61:2011 (First Edition) for use with IEC 60601-1: 2005 (Third Edition) + CORR.1 (2005) + CORR. 2 (2007)
Patient safety	All patient connections are electrically isolated.
Environmental	
Operating temperature	0°C to 40°C (32°F to 104°F)
Storage and shipping temperature	-20°C to 60°C (-4°F to 140°F)
Humidity	5% to 95% relative humidity, noncondensing
Vibration	IEC 68-2-6 and IEC 68-2-34
Shock	IEC 68-2-27, 50 g 6ms half sine
Operating pressure	594 to 1060 millibars (-1253 to 14046 ft.)
Particle and water ingress	IEC 529, IP 22

Electromagnetic compatibility (EMC)	CISPR 11 Class B - radiated and conducted emissions
Electromagnetic immunity	AAMI DF80; EN 61000-4-3 to 10 V/m
Electrostatic discharge	AAMI DF80; EN 61000-4-2
Conducted susceptibility	EN 61000-4-4, 61000-4-5, 61000-4-6
Display	
Screen type	High-resolution, liquid crystal display (LCD)
Screen size	6.5 inches (16.5 cm) diagonally
Display format	Nonfade moving bar display.
Sweep speed	25 mm/s
Viewing time	5 seconds 4 seconds with certain monitoring parameter options
Messages	ERASING REPORT, INSERT CARD, REPLACE BATTERY, LOW BATTERY, PERFORM CPR, NOISY ECG, RETRY ANALYSIS, CHECK PATIENT, ANALYSIS HALTED, PRESS ANALYZE, NO SHOCK ADV., SHOCK ADVISED, PRESS CHARGE, SELECT PADS, SELECT ECG LEADS, SELECT DEFIB MODE, VF ALARMS OFF, REMOVE SYNC, CHECK PADS, ATTACH PADS, POOR PAD CONTACT, DEFIB PAD SHORT, PADDLE FAULT, ECG LEAD OFF, USE PADDLE DISCHG, CANNOT CHARGE, RELEASE SHOCK, PRESS SHOCK, 30J TEST OK, TEST FAILED, PACER DISABLED, DEFIB DISABLED, SET PACE MA, CHECK RECORDER, ANALYZING ECG, FULLY RELEASE, STOP CPR
Electrodes	
Hands-free therapy electrodes	<ul style="list-style-type: none"> • OneStep electrodes • Pro-padz • Stat-padz • Pediatric Pedi-padz®
Defibrillator	
Waveform	Rectilinear Biphasic
Energy selection (delivered to a 50Ω load)	<ul style="list-style-type: none"> • ADULT: 1, 2, 3, 4, 5, 6, 7 8, 9, 10, 15, 20, 30, 50, 75, 100, 120, 150, 200 joules (through front panel buttons or paddle buttons) • PEDIATRIC: 1, 2, 3, 4, 5, 6, 7 8, 9, 10, 15, 20, 30, 50, 70, 85, 100, 120, 150, 200 joules (through OneStep pediatric electrodes only)

Charge Time	<ul style="list-style-type: none"> • Less than 7 seconds with a new, fully charged battery (first 15 charges to 200 joules), with or without AC power at rated mains voltage. • For the fifteenth discharge at maximum energy, the charge time is less than 10 seconds, with or without AC power at rated mains voltage. Depleted batteries result in a longer defibrillator charge time. • Less than 15 seconds when operating without a battery, using AC power alone at 90% of the rated mains voltage. • Less than 25 seconds from the initial power on, with a new, fully charged battery pack (depleted by up to fifteen 200 Joule discharges) or when operating without a battery, using AC power alone at 90% or 100% of the rated mains voltage. • Less than 30 seconds from initial power on and after rhythm analysis (advisory mode) with a new, fully charged pack (depleted by up to fifteen 200 J discharges) and using AC power at 90% of rated mains voltage.
Patient Impedance Range	15 - 300 ohms
Energy display	Screen shows selected and delivered energy.
Synchronized mode	Synchronizes defibrillator discharge to the patient's R wave. SYNC is indicated on the display with R wave markers above the ECG waveform on the screen and stripchart. When ECG is monitored by the device, meets the DF-80:2003 requirement of 60ms maximum time delay between the peak of the R wave and the delivery of energy.
Charge controls	CHARGE button on front panel and apex paddle.
Paddles	Standard apex/sternum paddles. Adult plate slides off to expose smaller plate for pediatric patients.
Automatic Defibrillator Test	Verifies defibrillator charging and discharging without removing paddles from storage wells or with OneStep cable connected to the Test Port or OneStep electrodes.
Defibrillation advisory	Evaluates electrode connection and patient ECG to determine if defibrillation is required. Shockable rhythms: <ul style="list-style-type: none"> • Ventricular fibrillation (VF) with amplitude > 100 μV • Wide-complex ventricular tachycardia (VT) with rates greater than 150 beats per minute (adult), or 200 beats per minute (pediatric). Refer to "ECG Rhythm Analysis Algorithm Accuracy" on page A-30 for sensitivity and specificity performance.
CPR Monitoring	
Compression depth	<p>Adult: 0.75 to 3 inches \pm0.25 inches 1.9 to 7.6 cm \pm0.6 cm</p> <p>Pediatric: 0.4 to 3 inches \pm0.25 inches 1.0 to 7.6 cm \pm0.6 cm</p>
Compression rate	50 to 150 compressions per minute
ECG Monitoring	
Patient connection	3-lead cable, 5-lead cable, paddles, or hands-free therapy electrodes
Input protection	Fully defibrillator-proof. Special circuitry prevents distortion of ECG during pacer pulse.

Implanted pacemaker spike display	Dedicated circuitry detects most implanted pacemaker spikes and provides standard display marker of spike on ECG trace.
Implanted Pulses Detected	<p>± 2 mV to ± 700mV amplitude, 0.1ms to 2ms width, with a recharge constant of 0 to 100ms.</p> <p>Note: The pacemaker pulse rejection capability for the R Series with pacemaker pulses alone includes pulses between ± 2mV and ± 700mV amplitude, with widths between 0.1ms and 2ms and overshoot from 0 to 100ms.</p> <p>The pacemaker pulse rejection capability for the R Series with pacemaker pulses and a normally paced QRS and T wave includes pulses between ± 2mV and ± 700mV amplitude, with widths between 0.1ms and 2ms and overshoot from 0 to 100ms.</p> <p>The pacemaker pulse rejection capability for the R Series with pacemaker pulses with an ineffectively paced QRS pattern includes pulses between ± 2mV and ± 700mV amplitude, with widths between 0.1ms and 2ms and overshoot from 0 to 100ms.</p> <p>The R Series is not capable of rejecting A-V Sequential pacemaker pulses.</p>
Bandwidth	0.5 Hz to 21 Hz standard; 0.05 Hz to 150 Hz diagnostic 0.5 Hz to 40 Hz, and 1 Hz to 21 Hz as configurable options
Lead selection	I, II, III, aVR, aVL, aVF, V, PADS, PADDLES, INTL PADDLES P1, P2, P3 with OneStep Pacing electrodes
ECG size relative scale factor	x0.5, x1, x1.5, x2 or x3 Current value shown on display.
Heart rate range	30 to 300 beats per minute
Heart rate accuracy	$\pm 5\%$
Heart rate alarm	Screen icon indicates activated/deactivated status. User selectable. Tachycardia: 60 to 280 beats per minute Bradycardia: 20 to 100 beats per minute
Tall T-wave Rejection	≤ 0.8 mV
Heart Rate Averaging	<p>The R Series averages the interval between the last 6 detected beats. On startup, the R Series averages the rate between detected beats once two beats are detected, until a full 6 beats have been received. The rate is updated every beat. After this condition is met, the meter is updated every beat with an average of the last 6 beats.</p> <p>If a period of time greater than 5 seconds elapses without a beat detected, the heart rate meter reports a rate of 0 bpm, which is repeated every 5 seconds.</p>
Accuracy and Response Time to Irregular Rhythm	<p>Averaging over 5 R -R intervals, per AAMI EC 13:2002:</p> <ul style="list-style-type: none"> Ventricular bigeminy (Figure 3a) - 80.5 bpm Slow alternating ventricular bigeminy (Figure 3b) - 60.5 bpm Slow alternating ventricular bigeminy (Figure 3c) - 120.5 bpm Bidirectional systoles (Figure 3d) - 93.3 bpm
Response Time to Change in Heart Rate	<ul style="list-style-type: none"> 3 seconds maximum for a step increase from 80 bpm to 120 bpm 6 seconds maximum for a step decrease from 80 bpm to 40 bpm

Time to Alarm for Tachycardia	from NSR 80 to VT 195 at 1 mV: 4 seconds from NSR 80 to VT 195 at 2 mV: 4 seconds from NSR 80 to VT 195 at 4 mV: 4 seconds from NSR 80 to VT 206 at 0.5 mV: 4 seconds from NSR 80 to VT 206 at 1 mV: 4 seconds from NSR 80 to VT 206 at 2 mV: 4 seconds
Leads Off Sensing	A DC current of 0.04 uA per lead wire is supplied to the patient.
Active Noise Suppression	The sum of all leadwire currents is returned via the active noise suppression leadwire: <ul style="list-style-type: none"> • 0.08 uA DC in 3 lead mode • 0.16 uA DC in 5 lead mode
Pacemaker option	
Type	VVI demand; asynchronous (fixed rate) when used without ECG leads or in asynchronous (Async) pacing mode
Pulse type	Rectilinear, constant current
Pulse duration	40 ms ±2 ms
Pulse amplitude (output)	Variable 0 mA to 140 mA ±5% or 5 mA, whichever is greater Increments/decrements by a value of 2 mA
Pacing rate	30 to 180 pulses per minute (ppm) ±1.5% Increments/decrements by a value of 2 ppm
Output protection	Fully defibrillator-protected and isolated
Recorder and Stripchart Printer	
Paper	80 mm thermal (grid width) 90 mm (paper width)
Speed	25 mm/s
Delay	6 seconds
Annotations	Time, date, defibrillation energy, heart rate, pacer output, QRS synchronization marker, ECG size, ECG lead, alarm, defibrillator test result, analyze ECG, diagnostic bandwidth Messages: <i>ANALYSIS HALTED, NOISY ECG, SHOCK ADVISED, NO SHOCK ADV.</i>
Printing method	High-resolution, thermal array print head
Printout modes	Manual or automatic; user-configurable
Data card	
Type	Compact flash card
Sync in / Marker out / ECG out	

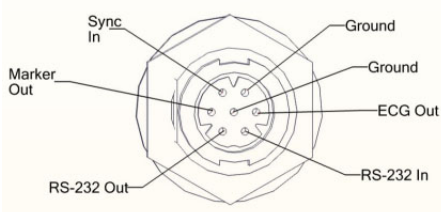
<p>Sync In</p>	<p>0-5 V (TTL Level) pulse, active high, 5 to 15 msec in duration, no closer than 200 ms apart. Energy transfer begins within 25 ms of the leading edge of the external sync pulse.</p>	<p style="text-align: center;">R Series Connector Pinout</p>  <p>SWITCHCRAFT CONXALL 17982-7SG-300 Mating Connector: SWITCHCRAFT CONXALL 16982-7PG-522</p>
<p>Marker Out</p>	<p>0-5 V (TTL Level) pulse, active high, 10 ms in duration, the leading edge of the pulse occurs within 35 ms of the peak of the R-wave)</p>	
<p>ECG Out</p>	<p>1.0 V/cm of deflection on stripchart recorder <25 ms delay from patient ECG input</p>	
Wi-Fi Card		
<p>ZOLL R Series Data COMM II</p>	<p>Model: 802.11 abgn Wireless LAN Compact Flash Card</p>	

Battery Pack Specifications

Type	Rechargeable lithium ion
Weight	1.7 lb (0.77 kg)
Nominal voltage	10.6 V
Recharge time	4 hours or less within R Series.
Operating time	For a new, fully charged battery at 20°C: <ul style="list-style-type: none"> • 100 defibrillator discharges at maximum energy (200 joules), or • 4 hours of continuous ECG monitoring, or • 3.5 hours of continuous ECG monitoring and pacing at 60 mA, 80 pulses per minute
Low battery indicator	The message <i>LOW BATTERY</i> is displayed on the screen when there is approximately 15 minutes of ECG monitoring time left on the battery. Two-beep low battery tone sounds once a minute until just before shutdown when the unit beeps twice every 2 seconds. The time from display of the message <i>LOW BATTERY</i> or <i>REPLACE BATTERY</i> until the defibrillator shuts down varies depending on the battery age and condition.
Battery Shelf Life	3 months before retest and recharge

IEC 60601-1-2 Specifications

This section provides specification tables for the R Series as per IEC 60601-1-2.

Electromagnetic Emissions Declaration

Emissions test	Compliance	Electromagnetic environment – guidance
RF Emissions CISPR 11	Group 1	The R Series uses RF energy for its internal function only. Therefore, its RF emissions are very low and are not likely to cause any interference in nearby electronic equipment.
RF Emissions CISPR 11	Class B	The R Series is suitable for use in all establishments, including domestic establishments and those directly connected to the public low-voltage power supply network that supplies buildings used for domestic purposes.
Harmonic Emissions IEC 61000-3-2	Class A	
Voltage Fluctuations/ Flicker Emissions IEC 61000-3-3	Complies	
Medical electrical equipment requires special precautions regarding electromagnetic compatibility and must be installed and put into service in accordance with the EMC information provided in this document.		

Electromagnetic Immunity Declaration (EID)

Guidance and manufacturer's declaration — electromagnetic immunity for the R Series.

The ZOLL R Series device is intended for use in the electromagnetic environment specified below. Operation outside of this environment could result in the misinterpretation of the ECG rhythms or CPR signals, interference to the display or audio messages, or the inability to provide defibrillation therapy. The operator of the unit must ensure that it is used in this environment.

The ZOLL R Series defibrillator's essential performance energy delivery (defibrillation, pacing, ECG rhythm analysis, ECG, CPR feedback, SpO₂, EtCO₂ and NIBP) is clinically acceptable, and the R Series defibrillator meets basic safety when operated in the electromagnetic environment specified in the following table.

The R Series is intended for use in the electromagnetic environment specified below. Operation outside of this environment could result in the misinterpretation of the ECG rhythms or CPR signals, interference to the display or audio messages, or the inability to provide defibrillation therapy.			
Immunity test	IEC 60601 test level	Compliance level	Electromagnetic environment – guidance
Electrostatic discharge (ESD) IEC 61000-4-2	±8 kV contact ±15 kV air	±8 kV contact ±15 kV air	The relative humidity should be at least 30%.
Electrical fast transient/burst IEC 61000-4-4	±2 kV for power supply lines ±1 kV for input/output lines	±2 kV for power supply lines Not applicable	Mains power quality should be that of a typical commercial or hospital environment.
Surge IEC 61000-4-5	±1 kV differential mode ±2 kV common mode	±1 kV differential mode ±2 kV common mode	Mains power quality should be that of a typical commercial or hospital environment.
Voltage dips, short interruptions and voltage variations on power supply input lines IEC 61000-4-11	<5% U_T (>95% dip in U_T) for 0.5 cycle 40% U_T (60% dip in U_T) for 5 cycles 70% U_T (30% dip in U_T) for 25 cycles <5% U_T (>95% dip in U_T) for 5 seconds	<5% U_T (>95% dip in U_T) for 0.5 cycle 40% U_T (60% dip in U_T) for 5 cycles 70% U_T (30% dip in U_T) for 25 cycles <5% U_T (>95% dip in U_T) for 5 seconds	Mains power quality should be that of a typical commercial or hospital environment. If the user of the R Series requires continued operation during power mains interruptions, it is recommended that the R Series be powered by an uninterruptible power supply or a battery.
Power frequency (50/60 Hz) magnetic field IEC 61000-4-8	30 A/m	30 A/m	Power frequency magnetic fields should be at levels characteristic of typical location in a typical commercial or hospital environment.
NOTE 1: U_T is the AC mains voltage prior to the application of the test level.			
NOTE 2: ESD discharges may cause screen flickers, brief screen black outs and in extreme cases have the capability to reset the R Series unit. In the case of a system reset, it may be necessary to recharge the defibrillator or restart pacing. If EtCO ₂ or SpO ₂ monitoring fail due to an ESD event, the unit may require a power cycle to restart those features.			
NOTE 3: The use of accessories and cables other than those specified in the accessories section of this document may result in increased emissions or decreased immunity of the R Series defibrillator.			
NOTE 4: Certain areas in the hospital environment may control the relative humidity below 30%. In such areas the risk of ESD discharges may be higher than the levels in the R Series tested specifications. Operators should be aware of these conditions and take appropriate action.			

Electromagnetic Immunity

Guidance and manufacturer’s declaration – electromagnetic immunity.

<p>The functions of the R Series are intended for use in the electromagnetic environment specified below. Operation outside of this environment could result in the misinterpretation of the ECG rhythms or CPR signals, interference to the display or audio messages, or the inability to provide defibrillation therapy.</p>			
Immunity test	IEC 60601 test level	Compliance level	Electromagnetic environment – guidance
Conducted RF IEC 61000-4-6	3 Vrms 150 kHz to 80 MHz outside ISM bands ^a	3 Vrms	<p>Portable and mobile RF communications equipment should be used no closer to any part of the R Series, including cables, than the recommended separation distance calculated from the equation applicable to the frequency of the transmitter.</p> <p>Recommended separation distance</p> $d = 1.2 \sqrt{P}$
	10 Vrms 150 kHz to 80 MHz in ISM bands ^a	10 Vrms	$d = 1.2 \sqrt{P}$
Radiated RF IEC 60601-1-2, (wireless communications)	28 V/m for GSM 800/900, TETRA 800, iDEN 820, CDMA 850, or LTE Band 5 services (0.3 m separation)	28 V/m	$d = 0.3$ m minimum
	27 V/m for TETRA 400 service	27 V/m	$d = 0.3$ m minimum
	28 V/m for GMRS 460, FRS 460, GSM 1800, CDMA 1900, GSM 1900, DECT, LTE Band 1, 3, 4, and 25, UMTS, Bluetooth, WLAN, 802.11 b/g/n, RFID 2450, and LTE Band 7 services	28 V/m	$d = 0.3$ m minimum
	9 V/m for LTE Band 13 and 17, and WLAN 802.11 a/n services	9 V/m	$d = 0.3$ m minimum

<p>Radiated RF IEC 61000-4-3 (ECG monitoring from Leads & PADS)</p>	<p>10 V/m 80 MHz to 2.7 GHz</p>	<p>10 V/m^d</p>	<p>$d = 1.2 \sqrt{P}$ 80 MHz to 800 MHz $d = 2.3 \sqrt{P}$ 800 MHz to 2.7 GHz</p>
<p>Radiated RF IEC 61000-4-3 (EtCO₂, SpO₂, NIBP, and all other functions)</p>	<p>3 V/m 80 MHz to 2.7 GHz</p>	<p>3 V/m^d</p>	<p>where P is the maximum output power rating of the transmitter in watts according to the transmitter manufacturer and d is the recommended separation distance in meters.^b Field strengths from fixed RF transmitters, as determined by electromagnetic site survey,^c should be less than the compliance level in each frequency range.^d Interference may occur in the vicinity of equipment marked with the following symbol:</p> <div style="text-align: center;">  </div>

NOTE 1: At 80 MHz and 800 MHz, the higher frequency range applies.
NOTE 2: These guidelines may not apply in all situations. Electromagnetic propagation is affected by absorption and reflection from structures, objects, and people.

- a. The ISM (industrial, scientific, and medical) bands between 150 kHz and 80 MHz are 6.765 MHz to 6.795 MHz; 13.553 MHz to 13.567 MHz; 26.957 MHz to 27.283 MHz; and 40.66 MHz to 40.70 MHz.
- b. The compliance levels in the ISM frequency bands between 150 kHz and 80 MHz and in the frequency range 80 MHz to 2.7 GHz are intended to decrease the likelihood that mobile/portable communications equipment could cause interference if it is inadvertently brought into patient areas. For this reason, an additional factor of 10/3 is used in calculating the recommended separation distance for transmitters in these frequency ranges.
- c. Field strengths from fixed transmitters, such as base stations for radio (cellular/cordless) telephones and land mobile radios, amateur radio, AM and FM radio broadcast and TV broadcast cannot be predicted theoretically with accuracy. To assess the electromagnetic environment due to fixed RF transmitters, an electromagnetic site survey should be considered. If the measured field strength in the location in which the R Series is used exceeds the applicable RF compliance level above, the R Series should be observed to verify normal operation. If abnormal performance is observed, additional measures may be necessary, such as reorienting or relocating the R Series.
- d. Over the frequency ranges 150 kHz to 80 MHz field strength should be less than 10 V/m, as shown within the compliance column to the left.

Recommended Separation Distances from RF Equipment for the R Series Functions

Recommended separation distances between portable and mobile RF communications equipment and the R Series.

<p>The functions of the R Series are intended for use in the electromagnetic environment in which radiated RF disturbances are controlled. The customer or user of the R Series can help prevent electromagnetic interference by maintaining a minimum distance between portable and mobile RF communications equipment (transmitters) and the R Series as recommended below, according to the maximum output power of the communications equipment.</p>				
Rated maximum output power of equipment (in watts)	Separation distance according to frequency of transmitter (in meters)			
	150 kHz to 80 MHz outside ISM bands	150 kHz to 80 MHz in ISM bands	80 MHz to 800 MHz	800 MHz to 2.7 GHz
	$d = 1.2 \sqrt{P}$	$d = 1.2 \sqrt{P}$	$d = 1.2 \sqrt{P}$	$d = 2.3 \sqrt{P}$
0.01	0.12	0.12	0.12	0.23
0.1	0.38	0.38	0.38	0.73
1	1.2	1.2	1.2	2.3
10	3.8	3.8	3.8	7.3
100	12	12	12	23
<p>For transmitters rated at a maximum output power not listed above, the recommended separation distance d in meters can be determined using the equation applicable to the frequency of the transmitter, where P is the maximum output power rating of the transmitter in watts according to the transmitter manufacturer.</p> <p>NOTE 1: At 80 MHz and 800 MHz, the separation distance for the higher frequency range applies.</p> <p>NOTE 2: The ISM (industrial, scientific, and medical) bands between 150 kHz and 80 MHz are 6.765 MHz to 6.795 MHz; 13.553 MHz to 13.567 MHz; 26.957 MHz to 27.283 MHz; and 40.66 MHz to 40.70 MHz.</p> <p>NOTE 3: An additional factor of 10/3 is used in calculating the recommended separation distances for transmitters in the ISM frequency bands between 150 kHz and 80 MHz and in the frequency range 80 MHz to 2.7 GHz to decrease the likelihood that mobile/portable communications equipment could cause interference if it is inadvertently brought into patient areas.</p> <p>NOTE 4: These guidelines may not apply in all situations. Electromagnetic propagation is affected by absorption and reflection from structures, objects, and people.</p>				

R Series Rectilinear Biphasic Waveform Characteristics

Table A-1 shows the characteristics of the R Series Rectilinear Biphasic™ waveform when discharged into 25 ohm, 50 ohm, 100 ohm, 125 ohm, 150 ohm and 175 ohm loads at the maximum energy setting of 200 joules.

Table A-1. R Series Rectilinear Biphasic Waveform Characteristics

	200 J discharged into					
	25Ω	50Ω	100Ω	125Ω	150Ω	175Ω
First phase						
Maximum initial current	31.4 A	30.4 A	19.7 A	19.4 A	16.7 A	15.6 A
Average current	27.1 A	24.9 A	17.5 A	16.2 A	14.4 A	13.2 A
Duration	6 ms	6 ms	6 ms	6 ms	6 ms	6 ms
Interphase duration (between first and second phases)						
	200 μs	200 μs	200 μs	200 μs	200 μs	200 μs
Second phase						
Initial current	29.2 A	18.8 A	15.1 A	13.2 A	12.1 A	11 A
Average current	14.7 A	13 A	12.5 A	11.3 A	10.7 A	9.9 A
Duration	4 ms	4 ms	4 ms	4 ms	4 ms	4 ms

Table A-2. Delivered Energy at Every Defibrillator Setting into a Range of Loads

Selected Energy	Load							Accuracy
	25Ω	50Ω	75Ω	100Ω	125Ω	150Ω	175Ω	
1 J	1 J	1 J	1 J	1 J	1 J	1 J	1 J	±3 J
2 J	1 J	2 J	2 J	2 J	2 J	2 J	2 J	±3 J
3 J	2 J	3 J	3 J	3 J	3 J	3 J	3 J	±3 J
4 J	3 J	4 J	4 J	5 J	5 J	5 J	4 J	±3 J
5 J	3 J	5 J	6 J	6 J	6 J	6 J	6 J	±3 J
6 J	4 J	6 J	7 J	7 J	7 J	7 J	7 J	±3 J
7 J	5 J	7 J	8 J	8 J	8 J	8 J	8 J	±3 J
8 J	5 J	8 J	9 J	9 J	10 J	9 J	9 J	±3 J
9 J	6 J	9 J	10 J	11 J	11 J	11 J	10 J	±3 J
10 J	7 J	10 J	12 J	12 J	12 J	12 J	12 J	±3 J
15 J	10 J	16 J	17 J	18 J	18 J	18 J	17 J	±3 J
20 J	14 J	21 J	23 J	24 J	24 J	24 J	23 J	±15%
30 J	21 J	32 J	35 J	36 J	37 J	36 J	35 J	±15%
50 J	35 J	54 J	59 J	61 J	62 J	61 J	59 J	±15%
70 J	49 J	76 J	83 J	85 J	87 J	86 J	83 J	±15%
75 J	53 J	81 J	89 J	91 J	93 J	92 J	89 J	±15%
85 J	60 J	92 J	101 J	104 J	106 J	104 J	101 J	±15%
100 J	71 J	109 J	119 J	122 J	125 J	123 J	119 J	±15%
120 J	85 J	131 J	143 J	147 J	150 J	147 J	143 J	±15%

Table A-2. Delivered Energy at Every Defibrillator Setting into a Range of Loads

Selected Energy	Load							Accuracy
	25Ω	50Ω	75Ω	100Ω	125Ω	150Ω	175Ω	
150 J	107 J	164 J	180 J	183 J	188 J	184 J	179 J	±15%
200 J	142 J	230 J	249 J	253 J	269 J	261 J	260 J	±15%

The R Series Rectilinear Biphasic waveform employs the same first and second phase timing, similar first and second phase currents/voltages, and essentially the same mechanisms for controlling defibrillation waveshape as the ZOLL M Series[®] defibrillator. The M Series and R Series defibrillation waveforms are considered substantially equivalent.

Figures A-1 through A-21 show the Rectilinear Biphasic waveforms that are produced when the R Series defibrillator is discharged into loads of 25, 50, 75, 100, 125, 150, and 175 ohms at each energy setting.

The vertical axis shows the current in amperes (A); the horizontal axis shows the duration of time in milliseconds (ms).

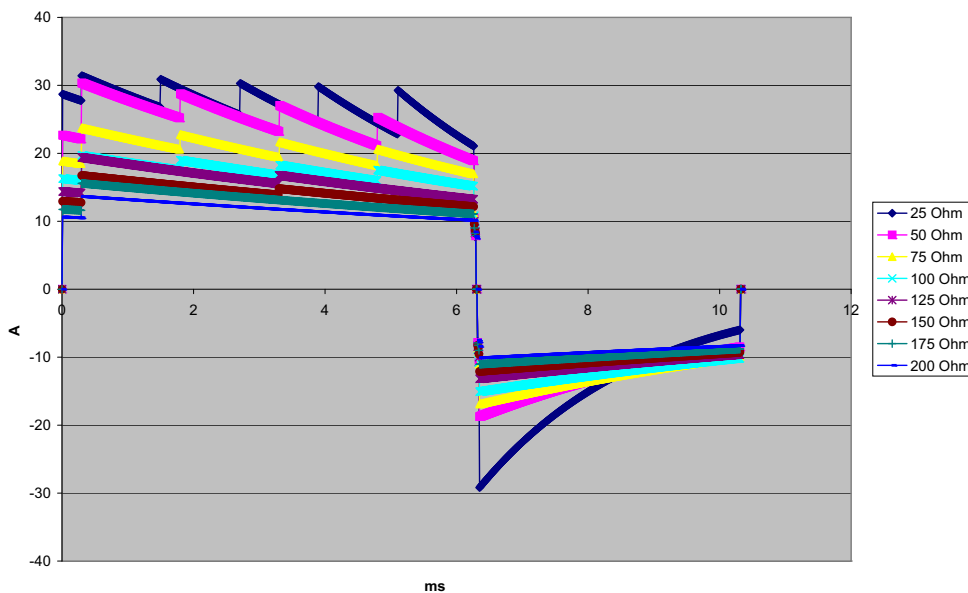

Figure A-1. Rectilinear Biphasic Waveform at 200 Joules

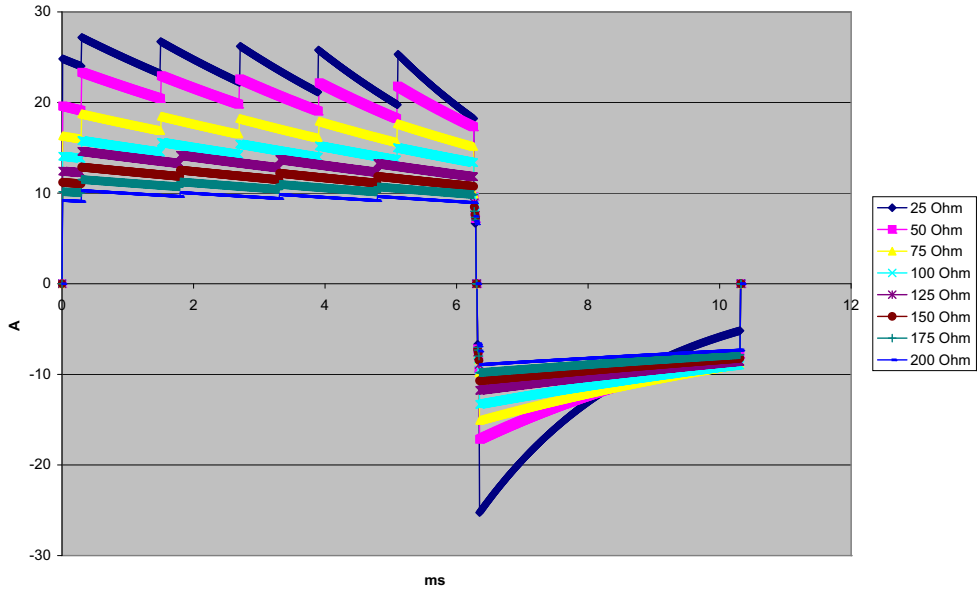

Figure A-2. Rectilinear Biphasic Waveform at 150 Joules

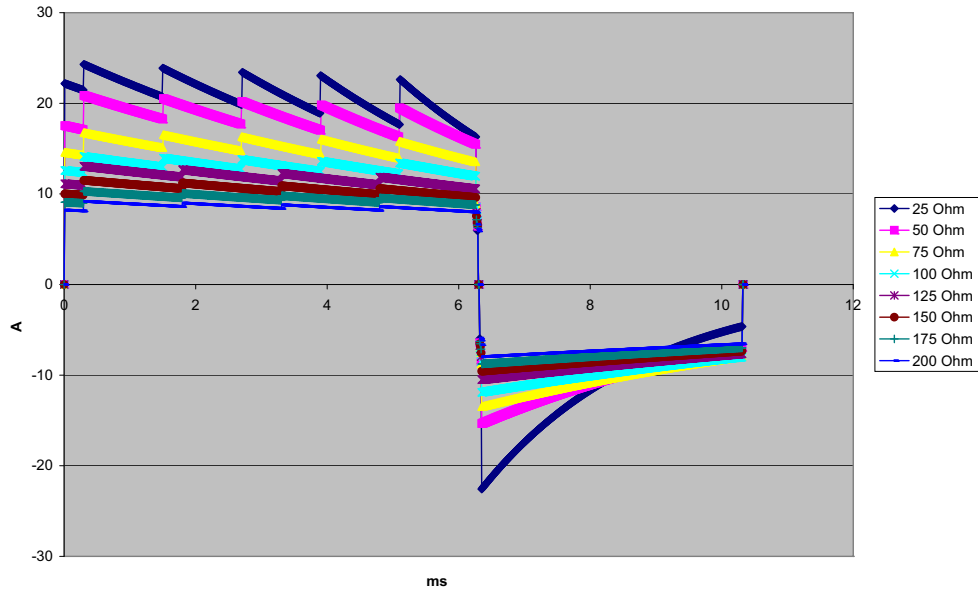

Figure A-3. Rectilinear Biphasic Waveform at 120 Joules

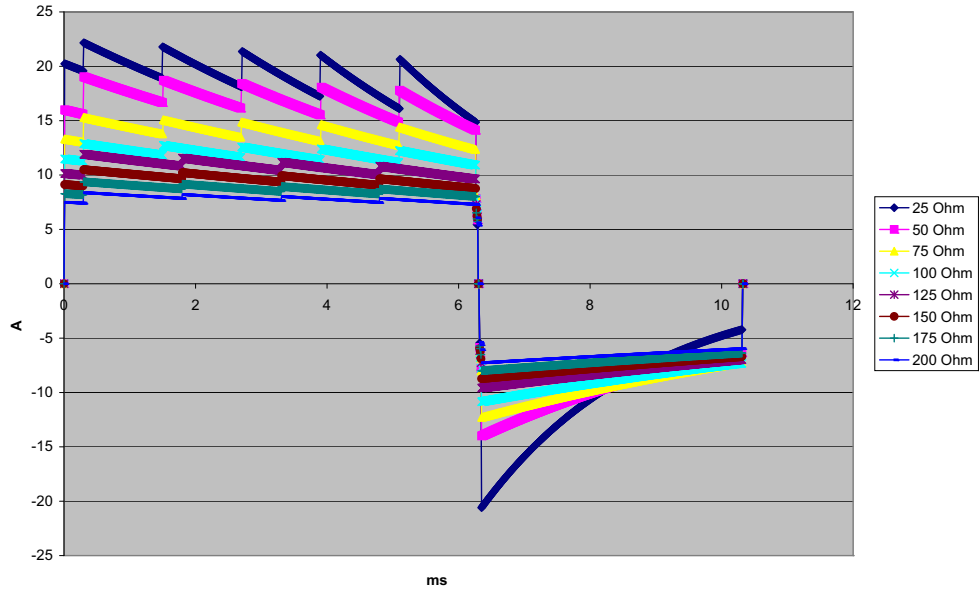

Figure A-4. Rectilinear Biphasic Waveform at 100 Joules

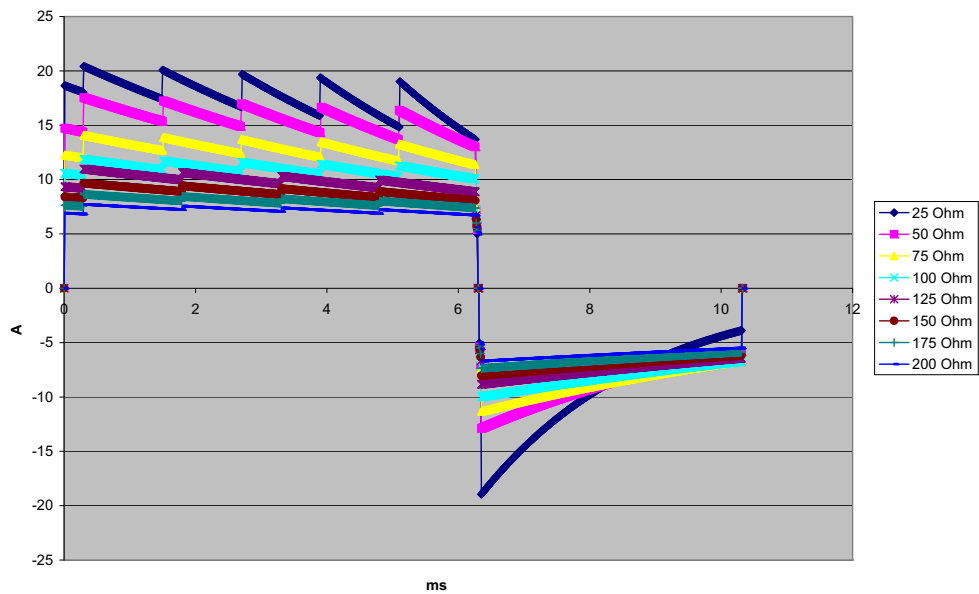

Figure A-5. Rectilinear Biphasic Waveform at 85 Joules

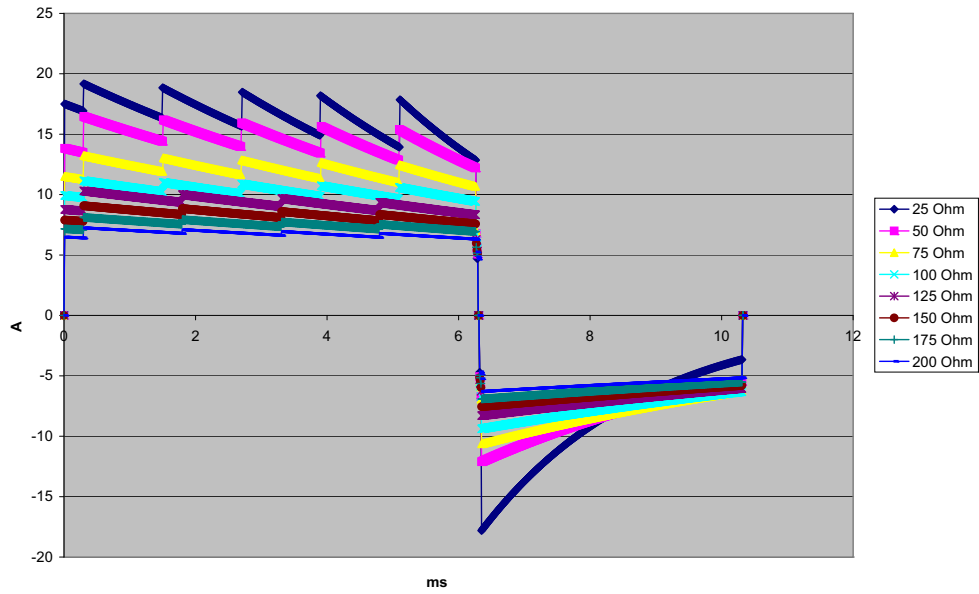

Figure A-6. Rectilinear Biphasic Waveform at 75 Joules

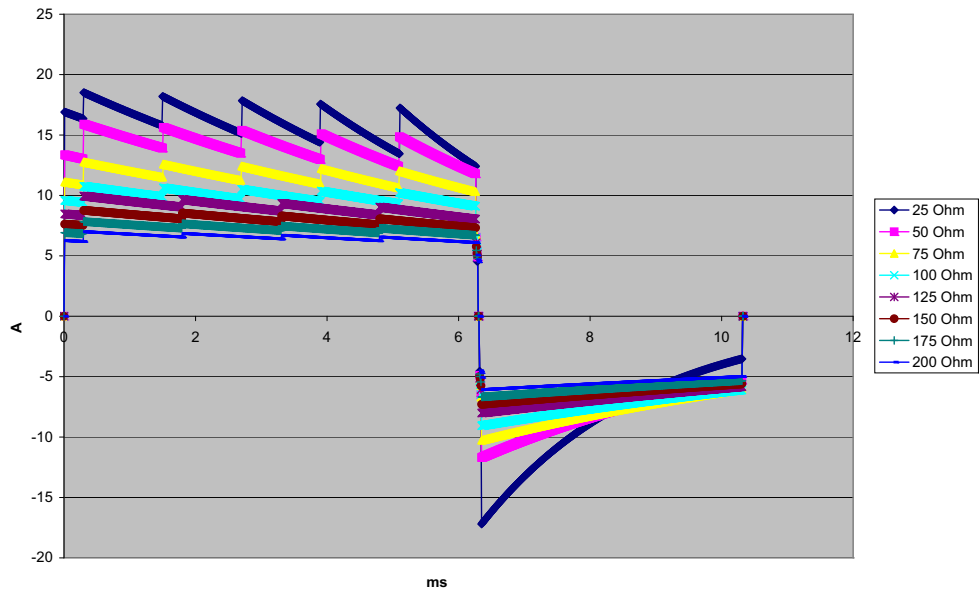

Figure A-7. Rectilinear Biphasic Waveform at 70 Joules

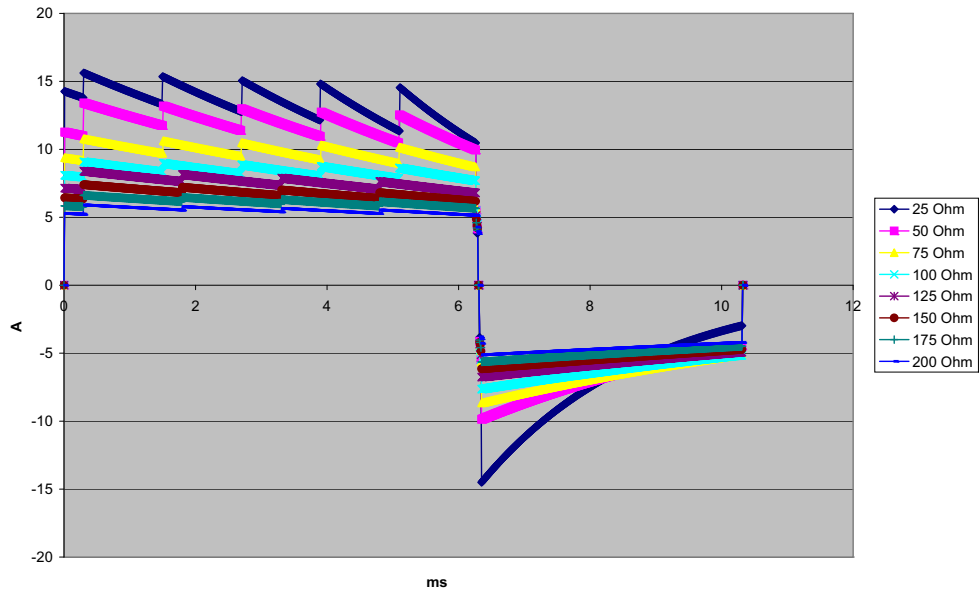

Figure A-8. Rectilinear Biphasic Waveform at 50 Joules

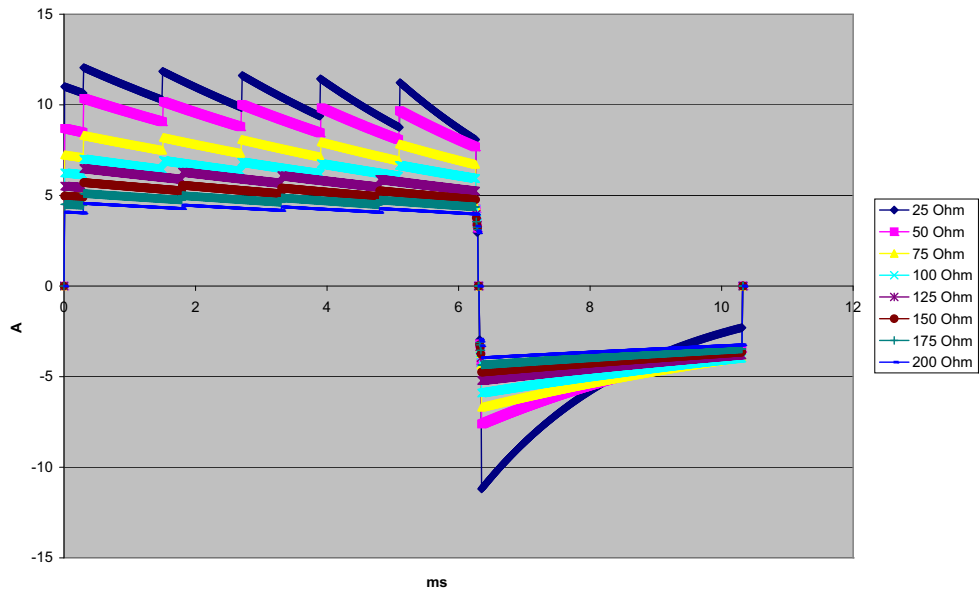

Figure A-9. Rectilinear Biphasic Waveform at 30 Joules

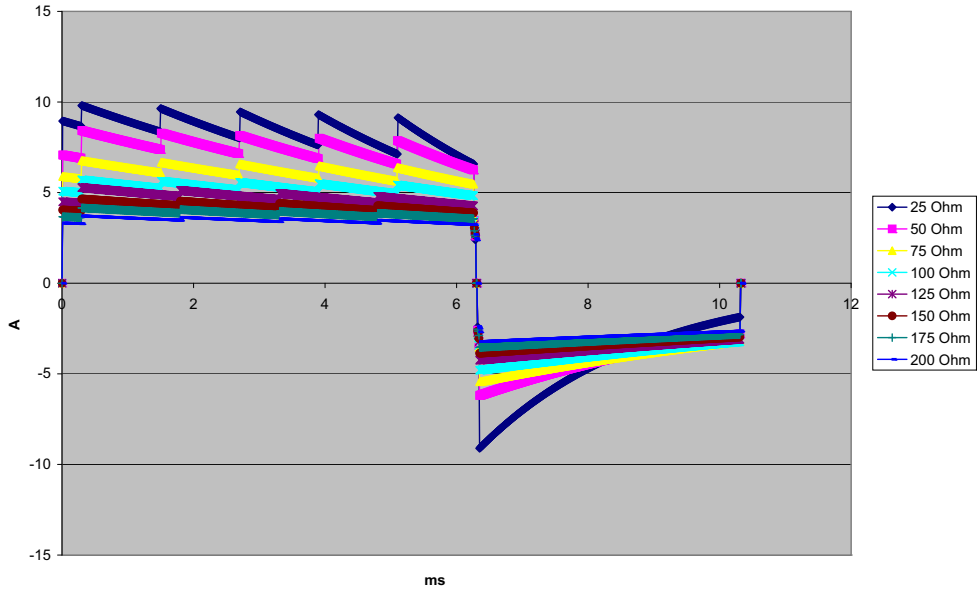

Figure A-10. Rectilinear Biphasic Waveform at 20 Joules

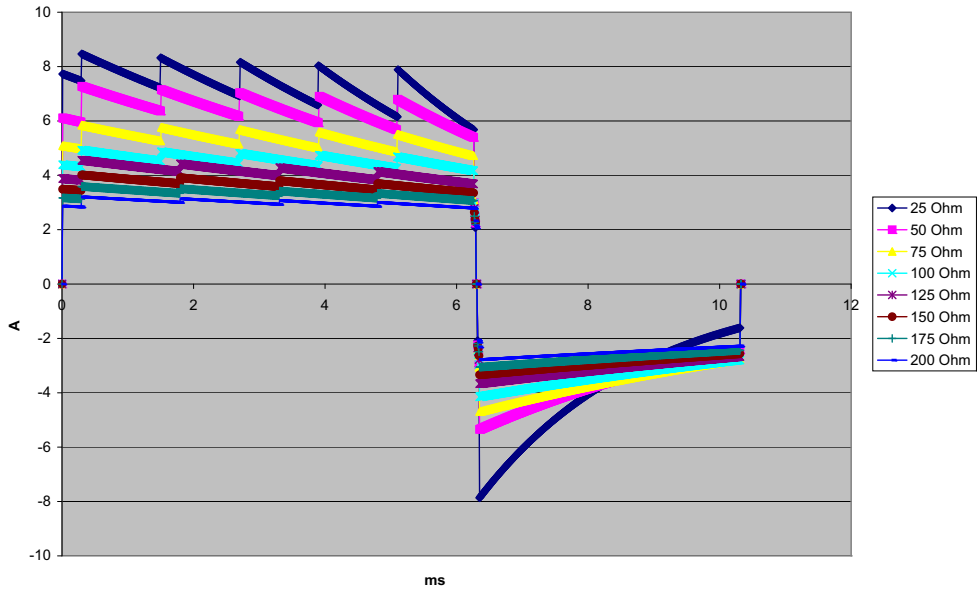

Figure A-11. Rectilinear Biphasic Waveform at 15 Joules

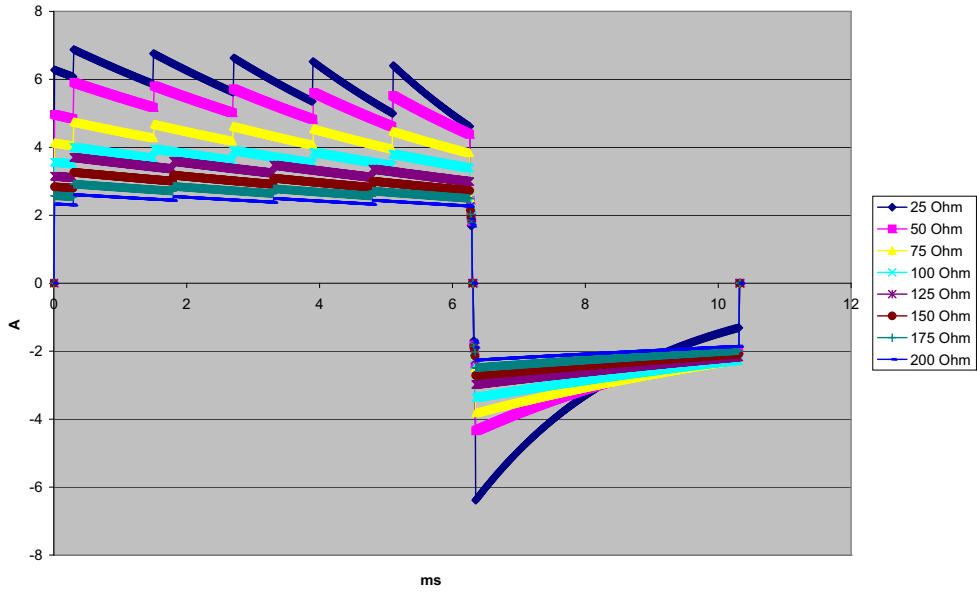

Figure A-12. Rectilinear Biphasic Waveform at 10 Joules

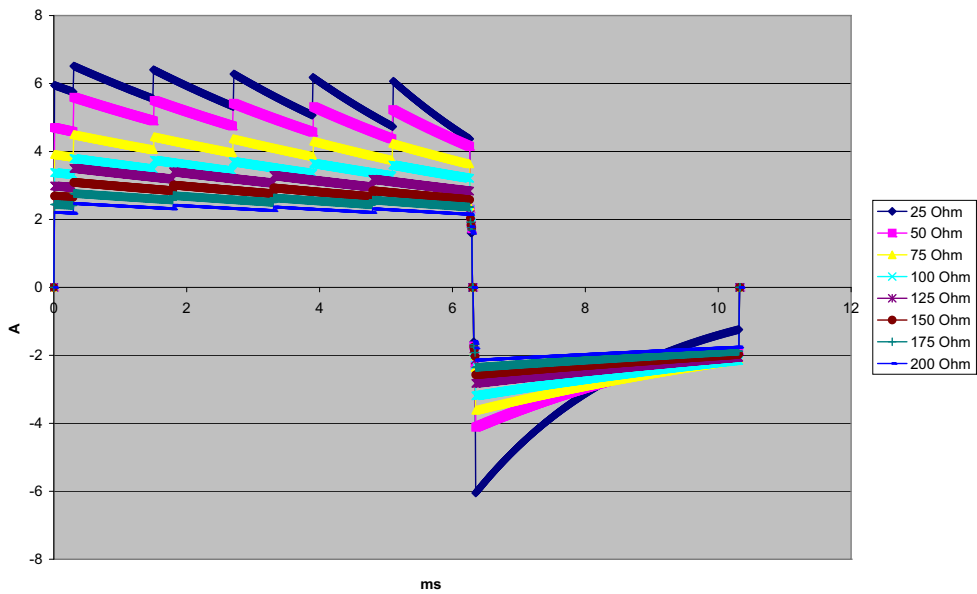

Figure A-13. Rectilinear Biphasic Waveform at 9 Joules

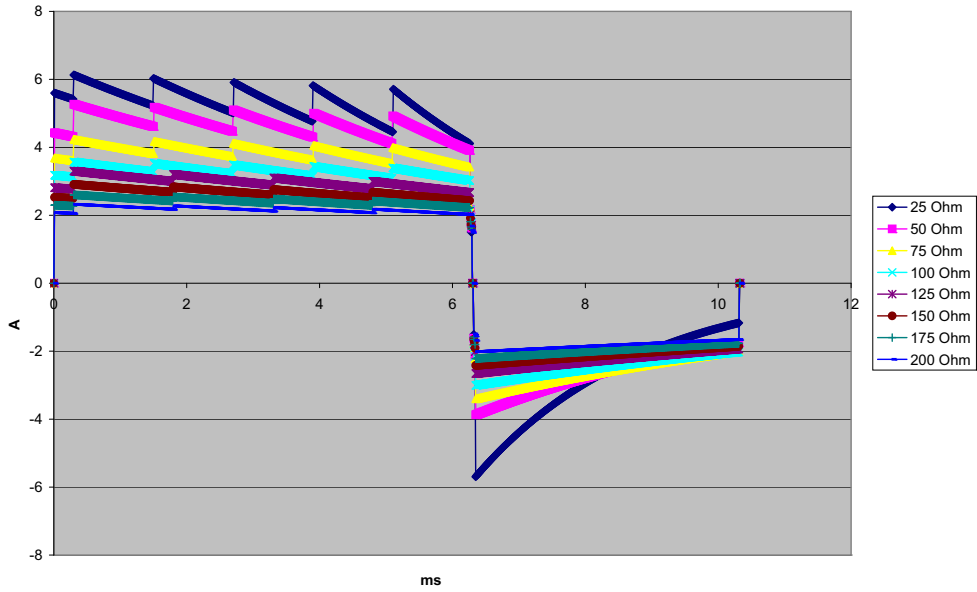

Figure A-14. Rectilinear Biphasic Waveform at 8 Joules

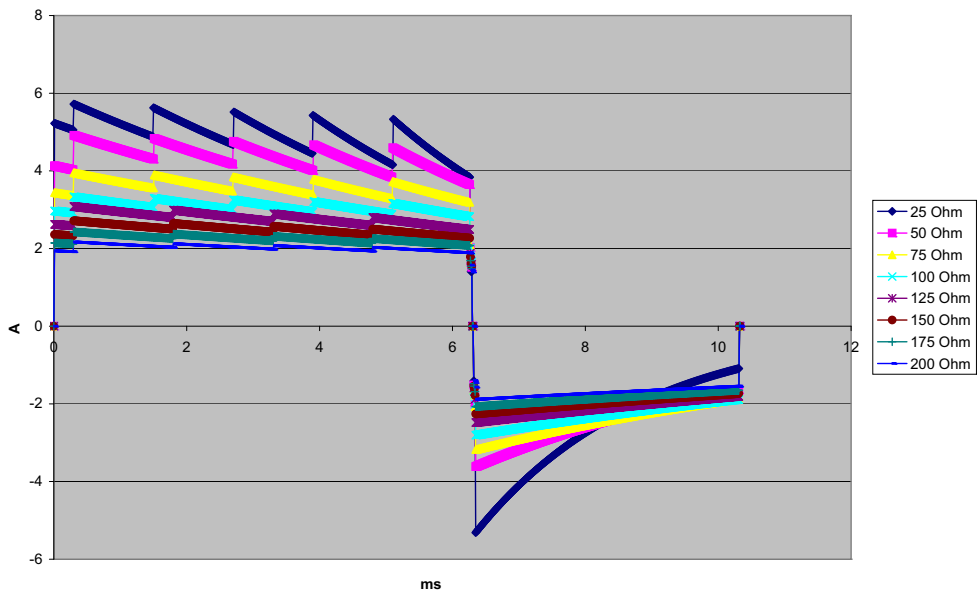

Figure A-15. Rectilinear Biphasic Waveform at 7 Joules

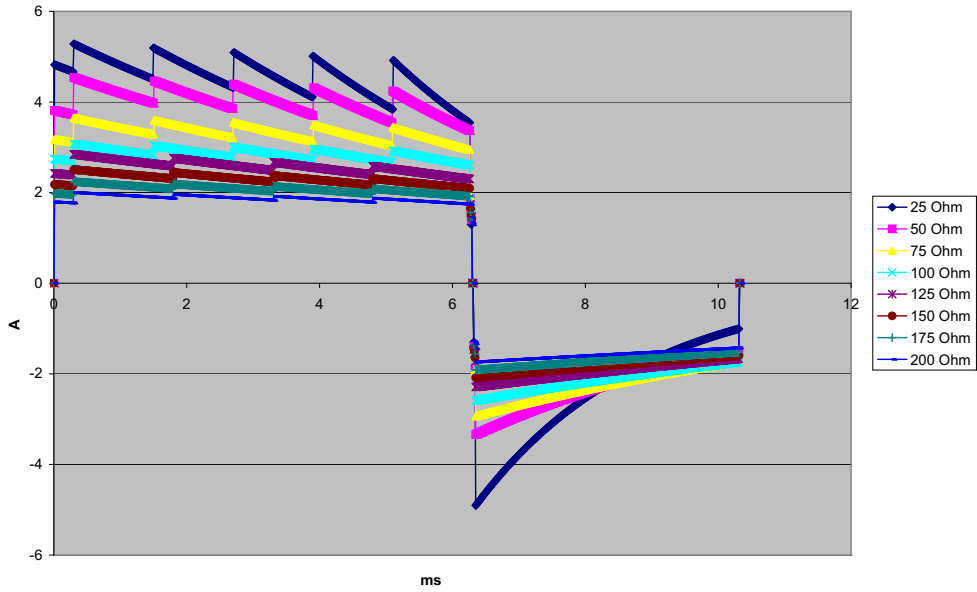

Figure A-16. Rectilinear Biphasic Waveform at 6 Joules

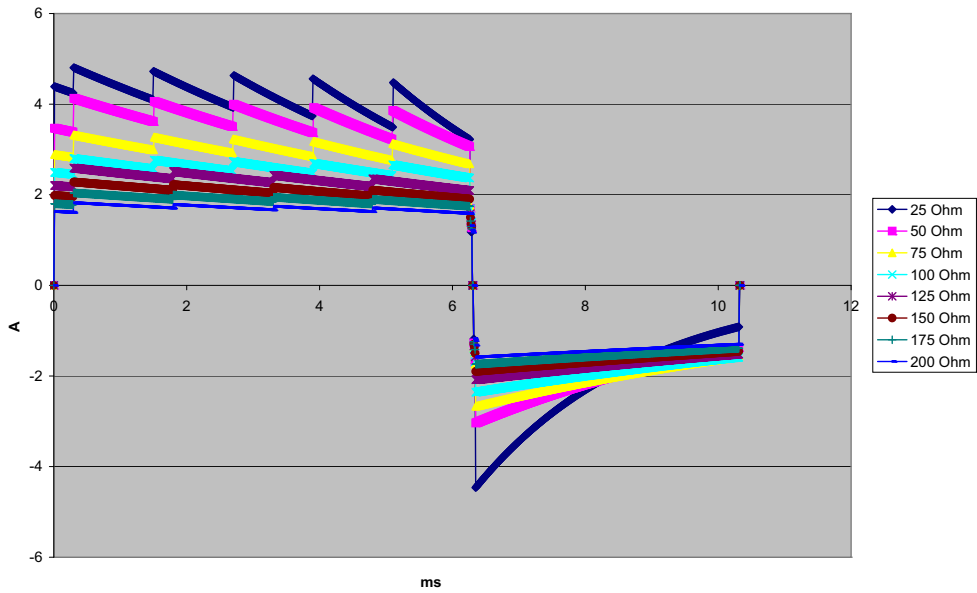

Figure A-17. Rectilinear Biphasic Waveform at 5 Joules

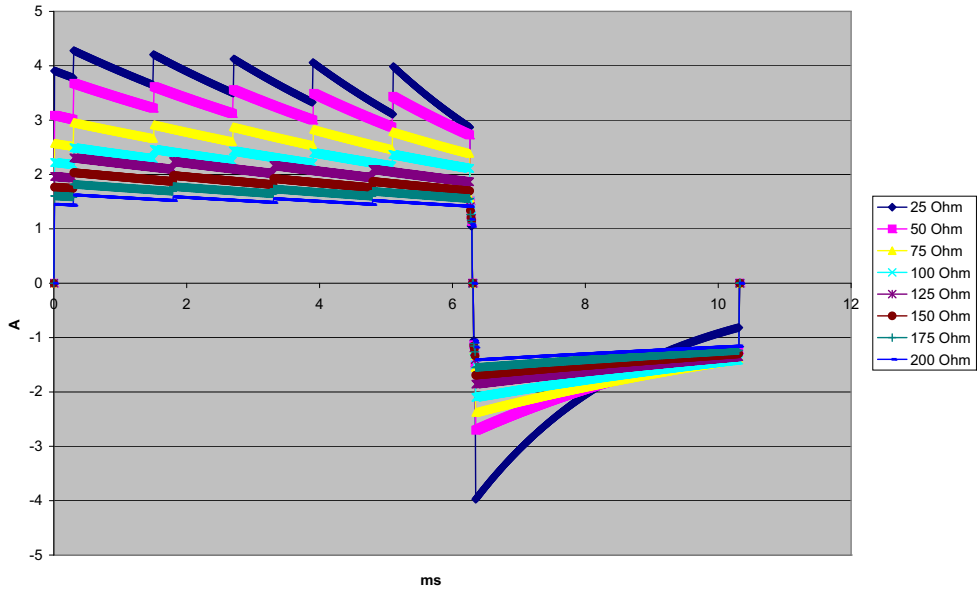

Figure A-18. Rectilinear Biphasic Waveform at 4 Joules

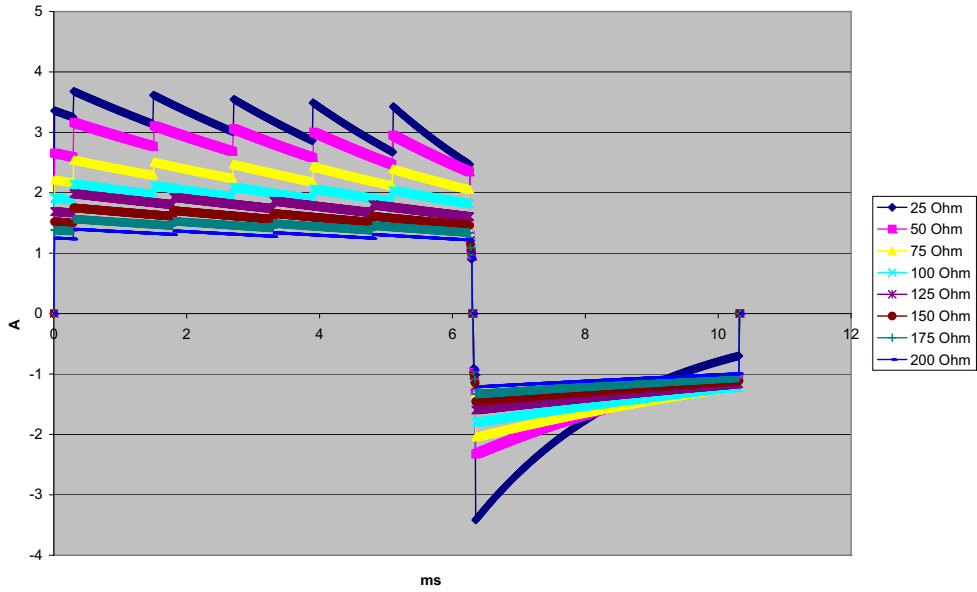

Figure A-19. Rectilinear Biphasic Waveform at 3 Joules

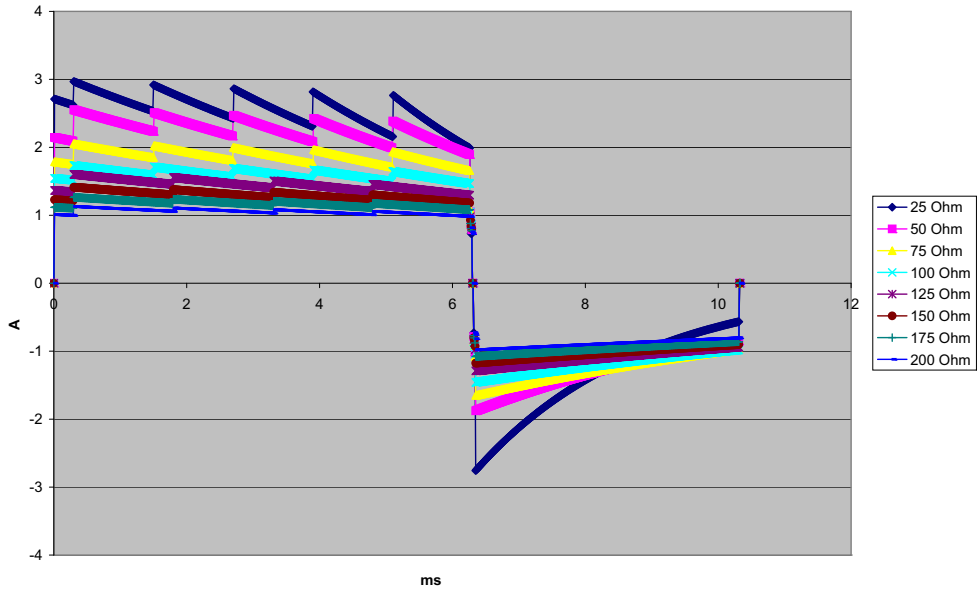

Figure A-20. Rectilinear Biphasic Waveform at 2 Joules

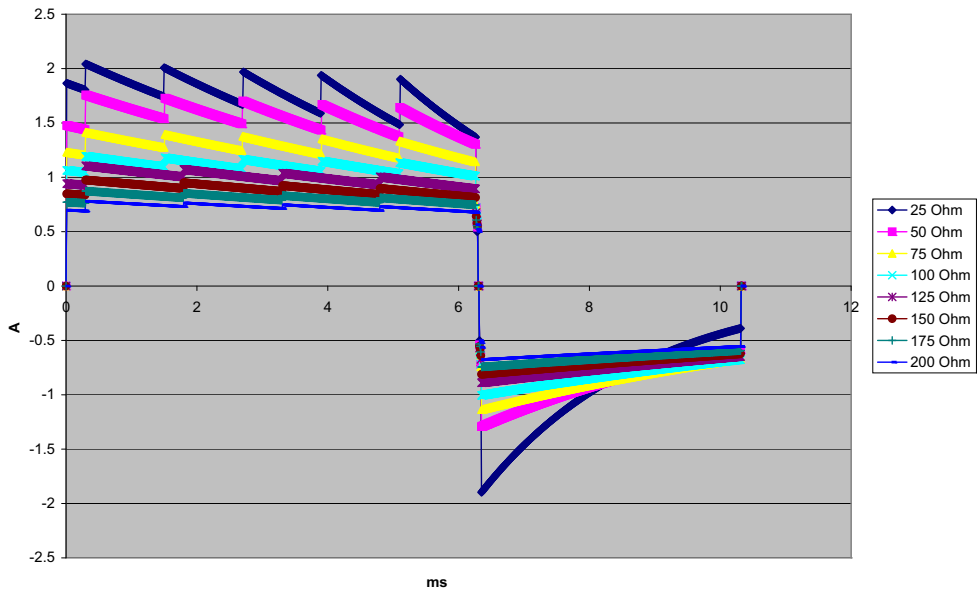

Figure A-21. Rectilinear Biphasic Waveform at 1 Joule

Clinical Trial Results for the Biphasic Waveform

The efficacy of the ZOLL Rectilinear Biphasic waveform has been clinically verified during a study of defibrillation of Ventricular Fibrillation (VF) and Ventricular Tachycardia (VT). A feasibility study was performed initially for defibrillation of VF/VT (n=20) on two separate groups of patients to ensure waveform safety and energy selection. Subsequently, a separate, multicenter, randomized clinical trial was performed to verify the waveform's efficacy. A description of this study is provided below. The study was performed using ZOLL defibrillation systems consisting of ZOLL defibrillators, the ZOLL Rectilinear Biphasic waveform, and ZOLL defibrillation electrodes.

Randomized Multicenter Clinical Trial for Defibrillation of Ventricular Fibrillation (VF) and Ventricular Tachycardia (VT)

Overview: The defibrillation efficacy of the ZOLL Rectilinear Biphasic waveform was compared to a monophasic damped sine waveform in a prospective, randomized, multicenter study of patients undergoing ventricular defibrillation for VF/VT during electrophysiological studies, ICD implants, and test. A total of 194 patients were enrolled in the study. Ten patients who did not satisfy all protocol criteria were excluded from the analysis, leaving a study population of 184.

Objectives: The primary goal of this study was to compare the first shock efficacy of the 120 J rectilinear biphasic waveform with a 200 J monophasic waveform. The secondary goal was to compare all shock (three consecutive 120, 150, and 170 joules) efficacy of the rectilinear biphasic waveform with that of a monophasic waveform (three consecutive 200, 300, and 360 joules). A significance level of $p=0.05$ or less was considered statistically significant using Fischer's Exact test. Also, differences between the two waveforms were considered statistically significant when the customary 95% or AHA-recommended 90%¹ confidence interval between the two waveforms was greater than 0%.

Results: The study population of 184 patients had a mean age of 63 ± 14 years. Of these, 143 patients were male. There were no adverse events or injuries related to the study.

The first shock, first induction efficacy of biphasic shocks at 120 J was 99% versus 93% for monophasic shocks at 200 J ($p=0.0517$, 95% confidence interval of the difference of -2.7% to 16.5% and 90% confidence interval of the difference of -1.01% to 15.3%).

Successful defibrillation with rectilinear biphasic shocks was achieved with 58% less delivered current than with monophasic shocks (14 ± 1 amperes versus 33 ± 7 amperes, $p=0.0001$).

The difference in efficacy between the rectilinear biphasic and the monophasic shocks was greater in patients with high transthoracic impedance (greater than 90 ohms). The first shock, first induction efficacy of biphasic shocks was 100% versus 63% for monophasic shocks for patients with high impedance ($p=0.02$, 95% confidence interval of the difference of -0.0217% to 0.759% and 90% confidence interval of the difference of 0.037% to 0.706%).

1. Kerber RE, et al., "Automated External Defibrillators for Public Access Defibrillation: Recommendations for Specifying and Reporting Arrhythmia Analysis Algorithm Performance, Incorporating New Waveforms, and Enhancing Safety," *Circ J Am Heart Assoc.* 1997;95:1677-1682.

"... the task force suggests that to demonstrate superiority of an alternative waveform over standard waveforms, the upper boundary of the 90% confidence interval of the difference between standard and alternative waveforms must be $<0\%$ (ie, alternative is greater than standard)."

A single patient required a second biphasic shock at 150 joules to achieve 100% efficacy versus six patients for whom monophasic shocks of up to 360 joules were required for 100% total defibrillation efficacy.

Conclusion: The data demonstrate the equivalent efficacy of low energy rectilinear biphasic shocks compared to standard high energy monophasic shocks for transthoracic defibrillation for all patients at the 95% confidence level. The data also demonstrate the superior efficacy of low energy rectilinear biphasic shocks compared to standard high energy monophasic shocks in patients with high transthoracic impedance at the 90% confidence level. There were no unsafe outcomes or adverse events due to the use of rectilinear biphasic waveform.

Pre-Clinical Study

To support pediatric usage for the ZOLL Rectilinear Bi-Phasic Waveform, ZOLL submitted pre-clinical data to the FDA as part of a 510(k) submission for its R Series device (cleared by the FDA under K060559). The protocol for this pre-clinical study, along with a summary of the results, have been submitted to FDA under R Series PMA application (P160022). A summary of this study is presented below.

To demonstrate the safety and efficacy of our Rectilinear Bi-Phasic Waveform when used to treat pediatric VF patients, ZOLL conducted a study using a porcine model of pediatric patients less than 8 years of age. This study included 18 piglets in three (3) size groups (two (2) animals weighing 4 kg, eight (8) animals weighing 8 kg, and eight (8) animals weighing 16 kg) and compared the defibrillation dose/response curves observed using proposed biphasic waveform with those observed using a standard monophasic damped sine wave (DSW) defibrillator to treat short duration (~ 30 seconds) ventricular fibrillation. The study demonstrated that the biphasic waveform defibrillates pediatric pigs with equal efficacy but lower energy (on a Joules/kg basis) than traditional monophasic damped sine wave defibrillators. To confirm the safety of the proposed biphasic waveform in pediatric patients, we studied and compared measures of cardiac function before and after both DSW and Rectilinear Bi-Phasic Waveform defibrillation shocks over a range of relevant energies. The study demonstrated that the biphasic defibrillation produced equivalent or milder disturbances of cardiac function when compared to traditional DSW defibrillation at the same energies.

Another animal study compared the ZOLL rectilinear biphasic (RLB) waveform to a biphasic truncated exponential (BTE) waveform. The study, using an immature porcine model (n=21), was a prospective, randomized, controlled design to determine the dose response curves for the RLB and BTE defibrillation waveforms. A weight range from 4 to 24 Kg for an animal represented a pediatric patient. The weight ranging from 4 to 8 Kg represented a patient less than 1 year old (infant subgroup), and the weight range from 16 to 24 Kg represented a pediatric patient between the ages of 2 and 8 years (young children subgroup).

The ZOLL RLB waveform demonstrated a superior capability to defibrillate a porcine pediatric model with < 90% of the D50 energy required for a BTE waveform (D50 energy: RLB 25.6 ± 15.7 J, BTE 28.6 ± 17.0 J, $P = 0.0232$; D90 energy: RLB 32.6 ± 19.1 J, BTE 37.8 ± 23.2 J, $P = 0.0228$).

The ECG ST segment changes (mV) and LV pressure changes (dP/dt) following a defibrillation shock were compared between the RLB waveform to the BTE waveform. The RLB waveform had an average ST segment increase above baseline of 0.138 ± 0.136 mV (N=401 shocks) compared to the BTE waveform's average increase of 0.146 ± 0.148 mV (N=396 shocks). The RLB waveform had an average dP/dt at the 40 mmHg threshold (the point in time when an animal's blood pressure exceeded 40 mmHg spontaneously) of 1987 ± 411 mmHg/s

(N=496 shocks) compared to the BTE waveform's average dP/dt of 2034 ± 425 mmHg/s (N=496 shocks).

Published Clinical Data

Additional clinical data was included with PMA application P160022 to support out-of-hospital use of ZOLL's Rectilinear Bi-Phasic defibrillation waveform. The data reported by Hess et al in Resuscitation (82 (2011) 685–689) is considered sufficient to support ZOLL's defibrillation waveform in the out-of-hospital environment. The resulting clinical paper, "Performance of a rectilinear biphasic waveform in defibrillation of presenting and recurrent ventricular fibrillation: A prospective multicenter study," was included with PMA application P160015. A summary of the study is presented below:

Objectives: The study tested the hypothesis that shock success differs with initial and recurrent episodes of ventricular fibrillation (VF).

Methods: From September 2008 to March 2010 out-of-hospital cardiac arrest patients with VF as the initial rhythm at 9 study sites were defibrillated by paramedics using a rectilinear biphasic waveform. Shock success was defined as termination of VF within 5 s post-shock. The study used generalized estimating equation (GEE) analysis to assess the association between shock type (initial versus defibrillation) and shock success.

Results: Ninety-four patients presented in VF. Mean age was 65.4 years, 78.7% were male, and 80.9% were bystander-witnessed. VF recurred in 75 (79.8%). There were 338 shocks delivered for initial (n = 90) or recurrent (n = 248) VF available for analysis. Initial shocks terminated VF in 79/90 (87.8%) and subsequent shocks in 209/248 (84.3%). GEE odds ratio (OR) for shock type was 1.37 (95% CI 0.68–2.74). After adjusting for potential confounders, the OR for shock type remained insignificant (1.33, 95% CI 0.60–2.53). The study observed no significant difference in ROSC (54.7% versus 52.6%, absolute difference 2.1%, p = 0.87) or neurologically intact survival to hospital discharge (21.9% versus 33.3%, absolute difference 11.4%, p = 0.31) between those with and without VF recurrence.

Conclusions: Presenting VF was terminated with one shock in 87.8% of cases. The study observed no significant difference in the frequency of shock success between initial versus recurrent VF. VF recurred in the majority of patients and did not adversely affect shock success, ROSC, or survival.

Randomized Multi-Center Clinical trial for Cardioversion of Atrial Fibrillation (AF)

Overview: The defibrillation efficacy of ZOLL's Rectilinear Biphasic Waveform was compared to a monophasic damped sine waveform in a prospective randomized multi-center study of patients undergoing cardioversion of their atrial fibrillation. A total of 173 patients entered the study. Seven (7) patients who did not satisfy all protocol criteria were excluded from the analysis. ZOLL disposable gel electrodes with surface areas of 78 cm² (anterior) and 113 cm² (posterior) were used exclusively for the study.

Objective: The primary goal of the study was to compare the total efficacy of four consecutive rectilinear biphasic shocks (70J, 120J, 150J, 170J) with four consecutive monophasic shocks (100J, 200J, 300J, 360J). The significance of the multiple shocks efficacy was tested statistically via two procedures, the Mantel-Haenszel statistic and the log-rank test, significance level of p=0.05 or less was considered statistically significant. The data are completely

analogous to the comparison of two "survival" curves using a life-table approach where shock number plays the role of time.

The secondary goal was to compare the first shock success of rectilinear biphasic and monophasic waveforms. A significance level of $p=0.05$ or less was considered statistically significant using Fisher Exact tests. Also, differences between the two waveforms were considered statistically significant when the 95% confidence interval between the two waveforms was greater than 0%.

Results: The study population of 165 patients had a mean age of 66 ± 12 years with 116 male patients.

The total efficacy of consecutive rectilinear biphasic shocks was significantly greater than that of monophasic shocks. The following table displays the Kaplan-Meier (product-limit) "survival" curves for each of the two waveforms. As all patients begin in the failure mode, the estimated life-table probabilities refer to the chance of still being in failure after the k^{th} shock ($k=1,2,3,4$):

Table A-3. Kaplan-Meier Estimate for the Probability of Shock Failure

Shock #	Biphasic	Monophasic
0	1.000	1.000
1	0.318	0.792
2	0.147	0.558
3	0.091	0.324
4	0.057	0.208

As can be seen from the table, the Biphasic experience is superior over the entire course of shocks delivered. The one degree of freedom chi-square statistic for the Mantel-Haenszel test is 30.39 ($p<0.0001$). Similarly, the log-rank test, also a one degree of freedom chi-square statistic, is 30.38 ($p<0.0001$). The residual number of patients not successfully treated after four shocks is 5.7% for biphasic compared to 20.8% for monophasic.

There was a significant difference between the first shock efficacy of biphasic shocks at 70J of 68% and that of monophasic shocks at 100J of 21% ($p=0.0001$, 95% confidence interval of the difference of 34.1% to 60.7%).

Successful cardioversion with rectilinear biphasic shocks was achieved with 48% less delivered current than with monophasic shocks (11 ± 1 vs. 21 ± 4 A, $p<0.0001$).

One half of the patients who failed cardioversion after four consecutive escalating monophasic shocks were subsequently successfully cardioverted using a biphasic shock at 170J. No patient was successfully cardioverted using a 360J monophasic shock after the patient had failed cardioversion with biphasic shocks.

Conclusion: The data demonstrate the superior efficacy of low energy rectilinear biphasic shocks compared to high energy monophasic shocks for transthoracic cardioversion of atrial fibrillation. There were no unsafe outcomes or adverse events due to the use of Rectilinear Biphasic Waveform.

Synchronized Cardioversion of Atrial Fibrillation

Cardioversion of atrial fibrillation (AF) and overall clinical effectiveness is enhanced by proper pad placement. Clinical studies (refer to above) of the M Series Biphasic Defibrillator Waveform demonstrated that high conversion rates are achieved when defibrillation pads are placed as shown in the diagram below.

Recommended Anterior/Posterior Placement

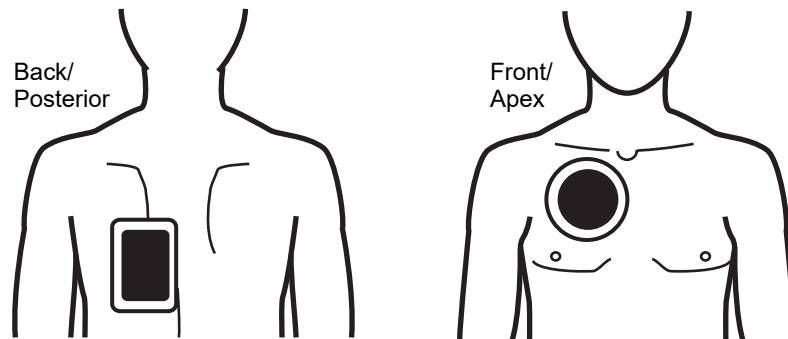

Place the front (apex) pad on the third intercostal space, mid clavicular line on the right anterior chest. The back/posterior pad should be placed in the standard posterior position on the patient's left as shown.

ECG Rhythm Analysis Algorithm Accuracy

Sensitivity and specificity are expressions of ECG rhythm analysis algorithm performance when compared to ECG interpretation by a clinician or expert. Sensitivity refers to the algorithm's ability to correctly identify shockable rhythms (as a percentage of the total number of shockable rhythms). Specificity refers to the algorithm's ability to correctly identify nonshockable rhythms (as a percentage of the total number of nonshockable rhythms).

The data in Table A-4 and Table A-5 summarize the accuracy of the ECG rhythm analysis algorithm as tested against ZOLL's ECG rhythm database. Rhythm sources included data records from ZOLL devices and public domain databases recorded with electrode systems and ECG signal processing characteristics similar to the R Series. Data records were of appropriate length to allow for satisfactory analysis.

The algorithm sequence takes approximately 9 seconds and proceeds as follows:

- Divides the ECG rhythm into 3-second segments
- Filters and measures noise, artifact, and baseline wander
- Measures baseline content ("waviness" at the correct frequencies – frequency domain analysis) of signal
- Measures QRS rate, width, and variability
- Measures amplitude and temporal regularity (autocorrelation) of peaks and troughs
- Determines if multiple 3-second segments are shockable and then prompts the operator to treat the patient

Table A-4. Clinical Performance Results (Adult Patients)

Rhythms	Sample Size	Performance Goals	Observed Performance	90% One-sided Lower Confidence Limit
Shockable		Sensitivity		
Coarse VF	536	>90%	100.0%	99.4%
Rapid VT	80	>75%	98.8%	99.2%
Nonshockable		Specificity		
NSR	2210	>99%	99.6%	99.8%
AF, SB, SVT, heart block, idioventricular, PVCs	819	>95%	100.0%	99.6%
Asystole	115	>95%	100.0%	97.4%
Intermediate				
Fine VF	69	Report only	94.2%	87.2%
Other VT	28	Report only	100.0%	89.9%

Table A-5. Clinical Performance Results (Pediatric Patients)

Rhythms	Sample Size (9 second records)	Performance Goals	Observed Performance	90% One-sided Lower Confidence Limit
Shockable (49 patients)		Sensitivity		
Coarse VF	49	>90%	100.0%	93.1%
Rapid VT	79	>75%	100.0%	96.3%
Nonshockable (155 patients)		Specificity		
NSR	208	>99%	100.0%	98.6%
AF, SB, SVT ^a , heart block, idioventricular, PVCs	348	>95%	99.4%	98.2%
Asystole	29	>95%	100%	90.2%
Intermediate (16 patients)				
Fine VF	0	Report only	—	—
Other VT	44	Report only	81.8%	89.6%

a. 161 of the 348 abnormal rhythm records were SVT (72 patients). The SVT heart rates ranged from 152 to 302 beats per minute.

Arrhythmia performance is reported according to the article, Kerber RE, Becker LB, Bourland JD, Cummins RO, Hallstrom AP, Michos MB, Nichol G, Ornato JP, Thies WH, White RD, Zuckerman BD. “Automated External Defibrillators for Public Access Defibrillation: Recommendations for Specifying and Reporting Arrhythmia Analysis Algorithm Performance, Incorporating New Waveforms, and Enhancing Safety,” *Circ J Am Heart Assoc.* 1997;95:1677-1682.

References

Young KD, Lewis RJ. “What is confidence? Part 2: Detailed definition and determination of confidence intervals”. *Ann Emerg Med.* September 1997;30:311-318.

Beyer WH. Percentage Points, F-Distribution Table. *CRC Standard Mathematical Tables.* 28th ed. Boca Raton, Fla: CRC Press; 1981:573.

Appendix B

R Series Accessories

The following accessories are compatible for use with R Series products. To order any of these items, contact your local ZOLL representative.

Note: For ZOLL accessories, the water ingress rating is IPx2 when attached to the R Series unit, regardless of the stated rating on individual packaging labels.

SPU = Single Patient Use

Electrodes/Pads, Paddles, and Connectors (ZOLL)
OneStep resuscitation electrodes
OneStep Basic Pacing/defibrillation electrodes with Monitor while Pace (MWP)
OneStep resuscitation electrodes with CPR (anterior/posterior)
OneStep resuscitation electrodes with CPR (anterior/anterior)
OneStep Complete
OneStep pediatric resuscitation electrodes (1 or 8 pair/box)
OneStep pediatric resuscitation electrodes with CPR (1 or 8 pair/box)
Adult, Multi-Function Pacing/Defibrillation Stat-padz (12 pair/box)
Pediatric, Multi-Function Pacing/Defibrillation Pedi-padz
External Paddle Assembly Apex/Sternum with built in pediatric electrodes
External autoclavable paddles
Internal autoclavable handles, no switch
Internal autoclavable handles, with switch
Molded autoclavable internal handles, no switch
Molded autoclavable internal handles, with switch

Cables (ZOLL)
OneStep Cable (100-240V, 50/60Hz)
OneStep Pacing Cable (100-240V, 50Hz)
Multi-Function cable with CPR-D connector
AAMI 3-Lead Wire ECG Patient Cable (6' or 12')
AAMI 3-Lead Wire ECG Patient Cable, ESU
IEC 3-Lead ECG Patient Cable
AAMI 5-Lead Wire ECG Patient Cable
IEC 5-Lead Wire ECG Patient Cable
Power Cord Extension Cable (12")
AC power cord
Batteries and Chargers (ZOLL)
SurePower Charger
SurePower Battery
SpO₂ Sensors and Cables (Masimo)
LNCS Amtx Single use sensor for patients > 30 kg
LNCS Pmtx Single use sensor for Pediatrics and Slender Adults 10-50 kg
LNCS Inf-L Single use sensor for Infants 3-20 kg
LNCS Neo-L Single use sensor for Neonates < 3 kg
LNCS NeoPt-L Single use sensor for Neonates < 1 kg (Pre-term)
LNCS DCI Reusable sensor for Adults and Pediatrics > 30 kg
LNCS DCIP Reusable sensor for Pediatrics 10-50 kg
RD SET Adult SpO ₂ Adhesive Sensor
RD SET Pediatric SpO ₂ Adhesive Sensor
RD SET Infant Adhesive Sensor
RD SET Neonatal/Adult SpO ₂ Adhesive Sensor
RD SET Neonatal SpO ₂ Adhesive Sensor

RD SET NeoPt-500 Neonatal SpO ₂ Non-Adhesive Sensor
RD SET DCI Adult SpO ₂ Sensor
RD SET DCIP Pediatric SpO ₂ Sensor
LNC-4 4' Reusable Patient Cable
LNC-10 10' Reusable Patient Cable
LNC Ext LNC Extension Cable, DB-9 Termination, 4ft
LNCS-to-LNOP Adapter Cable, LNCS Sensor to LNOP Patient Cable
LNOP DC-12 LNOP Adult Reusable Direct Connect 12' Cable
RD SET 5' Reusable Patient Cable
RD SET 12' Reusable Patient Cable
EtCO₂ Sensors and Cables (Respironics)
Mainstream
CAPNOSTAT 5 CO ₂ Sensor and Cable
SPU Pediatric/Adult Airway Adapter
SPU Neonatal/Pediatric Airway Adapter
Reusable Adult Airway Adapter
Reusable Neonatal/Pediatric Airway Adapter
SPU Pediatric/Adult Airway Adapter with Mouthpiece
CAPNO ₂ mask, Large Adult
CAPNO ₂ mask, Standard Adult
CAPNO ₂ mask, Pediatric
Sidestream
LoFlo Module and Cable
SPU Nasal CO ₂ Sampling Cannula, Adult
SPU Nasal CO ₂ Sampling Cannula, Pediatric
SPU Nasal CO ₂ Sampling Cannula, Infant/neonate
SPU Oral/Nasal CO ₂ Sampling Cannula, Adult
SPU Oral/ Nasal CO ₂ Sampling Cannula, Pediatric
SPU Nasal CO ₂ Sampling with O ₂ Delivery Cannula, Adult
SPU Nasal CO ₂ Sampling with O ₂ Delivery Cannula, Pediatric
SPU Oral/Nasal CO ₂ Sampling with O ₂ Delivery Cannula, Adult
SPU Oral/Nasal CO ₂ Sampling with O ₂ Delivery Cannula, Pediatric
SPU Adult/Pediatric Airway Adapter Kit (ET tube sizes > 4.0 mm)
SPU Adult/Pediatric Airway Adapter Kit with Nafion tubing (ET tube sizes > 4.0 mm)
SPU Pediatric/Infant Airway Adapter Kit (ET tube sizes ≤ 4.0 mm)
SPU Pediatric/Infant Airway Adapter Kit with Nafion tubing (ET tube sizes ≤ 4.0 mm)

NIBP Cuffs and Hoses
SunTech
Thigh, reusable: 38 to 50 cm (14.96 to 19.69 in.)
Large Adult, reusable: 31 to 40 cm (12.20 to 15.75 in.)
Adult, reusable: 23 to 33 cm (9.06 to 12.99 in.)
Small Adult, reusable: 17 to 25 cm (6.69 to 9.84 in.)
Child, reusable: 12 to 19 cm (4.72 to 7.48 in.)
ZOLL
Neonate #5, disposable: 8.0 cm to 15.0 cm (3.1 to 5.9 in.)
Neonate #4, disposable: 7.0 to 13.0 cm (2.8 to 5.1 in.)
Neonate #3, disposable: 6.0 to 11.0 cm (2.4 to 4.3 in.)
Neonate #2, disposable: 4.0 to 8.0 cm (1.6 to 3.1 in.)
Neonate #1, disposable: 3.0 to 6.0 cm (1.2 to 2.4 in.)
Air hose with pneumatic fittings 3 m (9.8 ft.)
Air hose with pneumatic fittings 1.5 m (4.9 ft.)
Miscellaneous (ZOLL)
Recorder Paper, 80mm Fan Fold (10 or 20 pkgs)
R Series Data COMM II Card

Appendix C

Wi-Fi Radio Module Information

If this defibrillator contains an optional low power Wi-Fi radio module, it transmits information between the defibrillator and a wireless network (infrastructure mode). The module complies with the following standards:

- Part 15 of the FCC Rules. Operation is subject to the following two conditions: (1) this device may not cause harmful interference, and (2) this device must accept any interference received including interference that may cause undesired operation (of the radio function).
- RSS 247 of Industry & Science Canada. Operation is subject to the following two conditions: (1) this device may not cause harmful interference, and (2) this device must accept any interference received including interference that may cause undesired operation (of the radio function).

Changes or modifications to Wi-Fi settings on R Series wireless communication accessories not expressly approved by the administrator responsible for compliance could void the user's authority to operate the equipment.

The user is cautioned to maintain 8 inches (20 cm) of space from the product to ensure compliance with FCC requirements.

FCC/IC/EU: This device is limited to indoor use in the 5150MHz to 5250MHz band.

Radio	Frequency Range (MHz)	Output Power (EIRP)
802.11a/b/g/n	2412 - 2472	14.8 dBm
	5180 - 5320	15.4 dBm
	5500 - 5700	15.3 dBm

(This page intentionally left blank.)